

TECH TECH CONTROLLERS

USER MANUAL

EU-WiFi 8s

EN



TABLE OF CONTENTS

I.	Safety	5
II.	Device description	6
III.	Principle of operation	6
IV.	How to install the controller	7
V.	First start-up	9
1.	How to configure internet connection	9
2.	How to configure external sensor	9
3.	How to configure temperature sensors and room regulators	9
4.	How to configure wireless thermostatic actuators STT-868/STT-869 (software version 2.1.8 and later)	10
5.	How to configure window sensors	11
VI.	Wireless communication	11
VII.	Main screen description	12
VIII.	Controller functions	15
1.	Block diagram - controller menu	15
2.	Zones	15
2.1.	Registration	15
2.2.	ON	16
2.3.	Type of sensor	16
2.4.	Pre-set temperature	16
2.5.	Hysteresis	16
2.6.	Calibration	16
2.7.	Actuators	16
2.8.	Window sensors	17
3.	External sensor	18
4.	Voltage-free contact	18
4.1.	Zones	18
4.2.	Activation delay	18
4.3.	Additional contact	18
5.	Fitter's menu	19
5.1.	Internet module	20
5.2.	Protections	20
5.3.	Time settings	20
5.4.	Screen settings	21
5.5.	Language	21
5.6.	Service menu	21
5.7.	Factory settings	21

6.	Software version	21
IX.	How to control the heating system online	22
1.	Home tab	23
2.	Zones tab	27
3.	Statistics tab	27
4.	Settings tab	28
X.	Software update	29
XI.	Technical data	29
XII.	Protections and alarms	30

KN. 11.08.2022

I. SAFETY

Before using the device for the first time the user should read the following regulations carefully. Not obeying the rules included in this manual may lead to personal injuries or controller damage. The user's manual should be stored in a safe place for further reference. In order to avoid accidents and errors, it should be ensured that every person using the device has familiarized themselves with the principle of operation as well as security functions of the controller. If the device is to be put in a different place, make sure that the user's manual is stored with the device so that any potential user has access to essential information about the device. The manufacturer does not accept responsibility for any injuries or damage resulting from negligence; therefore, users are obliged to take the necessary safety measures listed in this manual to protect their lives and property.



WARNING

- **A live electrical device!** Make sure the regulator is disconnected from the mains before performing any activities involving the power supply (plugging cables, installing the device etc.)
- The device should be installed by a qualified electrician.
- The regulator should not be operated by children.



WARNING

- The device may be damaged if struck by a lightning. Make sure the plug is disconnected from the power supply during storm.
- Any use other than specified by the manufacturer is forbidden.
- Before and during the heating season, the controller should be checked for condition of its cables. The user should also check if the controller is properly mounted and clean it if dusty or dirty.

Changes in the merchandise described in the manual may have been introduced subsequent to its completion on 11.08. 2022. The manufacturer retains the right to introduce changes to the structure or colours. The illustrations may include additional equipment. Print technology may result in differences in the colours shown.

We are committed to protecting the environment. Manufacturing electronic devices imposes an obligation of providing for environmentally safe disposal of used electronic components and devices. Hence, we have been entered into a register kept by the Inspection for Environmental Protection. The crossed-out bin symbol on a product means that the product may not be disposed of to household waste containers. Recycling of waste helps to protect the environment. The user is obliged to transfer their used equipment to a collection point where all electric and electronic components will be recycled.



II. DEVICE DESCRIPTION

The EU-WiFi 8s controller is an online wireless device for controlling electric actuators STT-868/STT-869 (software version 2.1.8 and later) (up to 6 actuators per zone). Its main task is to maintain constant temperature in the rooms with the use of actuators for 8 heating zones. The controller is equipped with an additional contact for switching on/off an additional device (e.g. a gas boiler).

Controller functions:

- Controlling up to 8 zones with the use of:
 - built-in temperature sensor
 - wired sensor
 - possibility of connecting 8 additional wireless sensors C-8r, C-mini or room regulators R-8b, R-8z or R-8bw (software version 2. 1. 19 and later)
- NO/NC relay output (e.g. for controlling the heating device which is activated when the room temperature is too low)
- Possibility of connecting up to 6 wireless electric actuators STT-868 or STT-869 in each zone (software version 2.1.8 and later)
- Software update via USB
- Each zone may be assigned an individual operation mode (constant temperature, time limit or 6 operation schedules)
- Compatible with C-8zr wireless external sensor
- Compatible with wireless window sensors C-2n (up to 6 sensors per zone)

Controller equipment:

- Power supply 5V
- Wired sensor C-7p

The heating system may be managed via a web application at www.emodul.eu. The eModul application may be downloaded from the Google Play store.

III. PRINCIPLE OF OPERATION

The EU-WiFi 8s controller decides if a given zone needs to be heated on the basis of current temperature value sent by the room sensor (C-8r, C-mini or C-7p) or the room regulator (R-8b, R-8z, R-8bw (software version 2. 1. 19 and later)), as well as the individual operation algorithm of the zone. If heating is necessary, the EU-WiFi 8s controller activates the voltage-free contact, which may be used e.g. for controlling the heating device, and opens the actuators registered in a given zone. The signal from each zone is transmitted to the EU-WiFi 8s controller via room regulators or room sensors. They communicate with the controller via radio signal. Each zone may be assigned wireless valve actuators STT-868/STT-869 (version 2.1.8 and later), which require registration.

IV. HOW TO INSTALL THE CONTROLLER

The controller should be installed by a qualified person.



WARNING

Risk of fatal electric shock from touching live connections. Before working on the controller switch off the power supply and prevent it from being accidentally switched on.

Remove the controller cover and connect the wires following the diagrams below and the connector labels. Keep the following order:

- power supply cable to the Micro USB port
- additional device

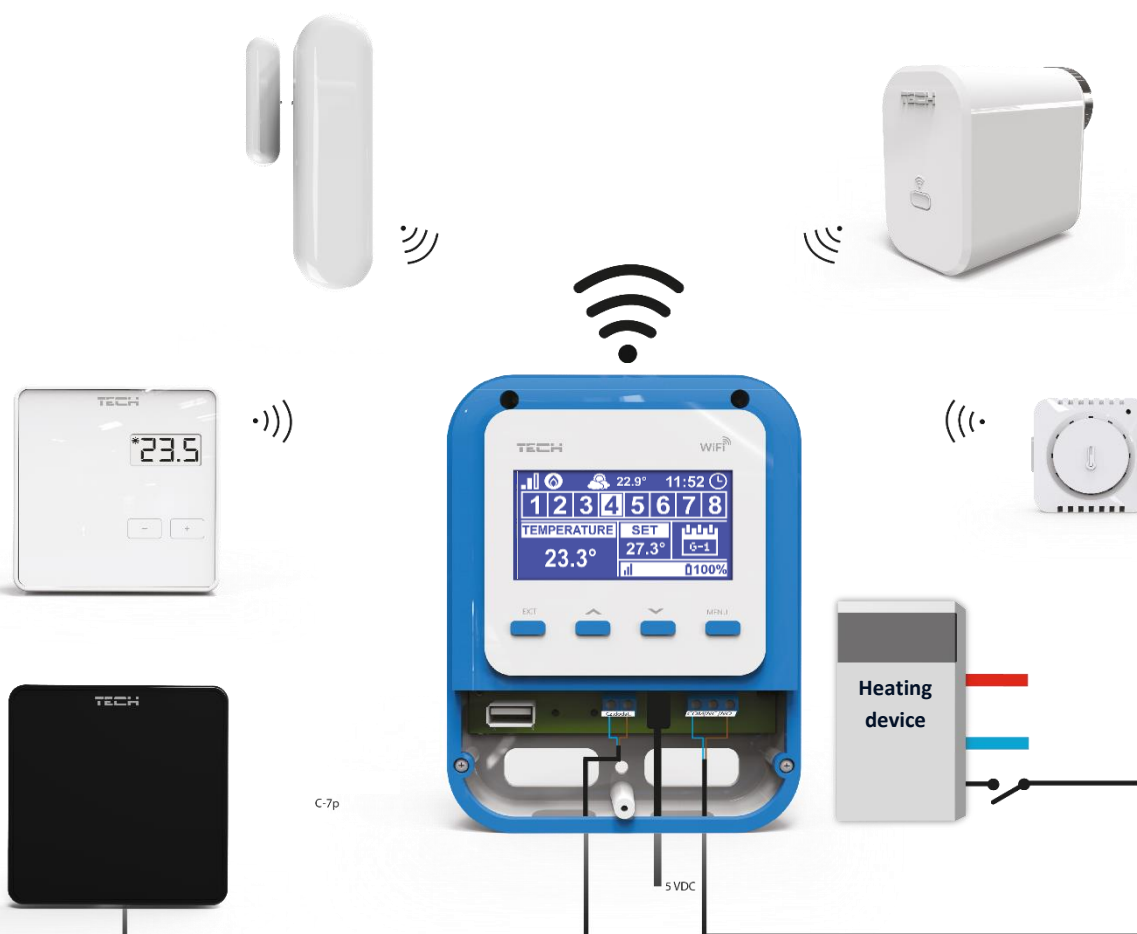

WARNING

If pump manufacturer requires an external main switch, power supply fuse or additional residual current device selective for distorted currents it is recommended not to connect pumps directly to pump control outputs.

To avoid damaging to the device, an additional safety circuit must be used between the regulator and the pump. The manufacturer recommends the ZP-01 pump adapter, which must be purchased separately.

Schematic diagram of wiring-up and communication between heating system devices:

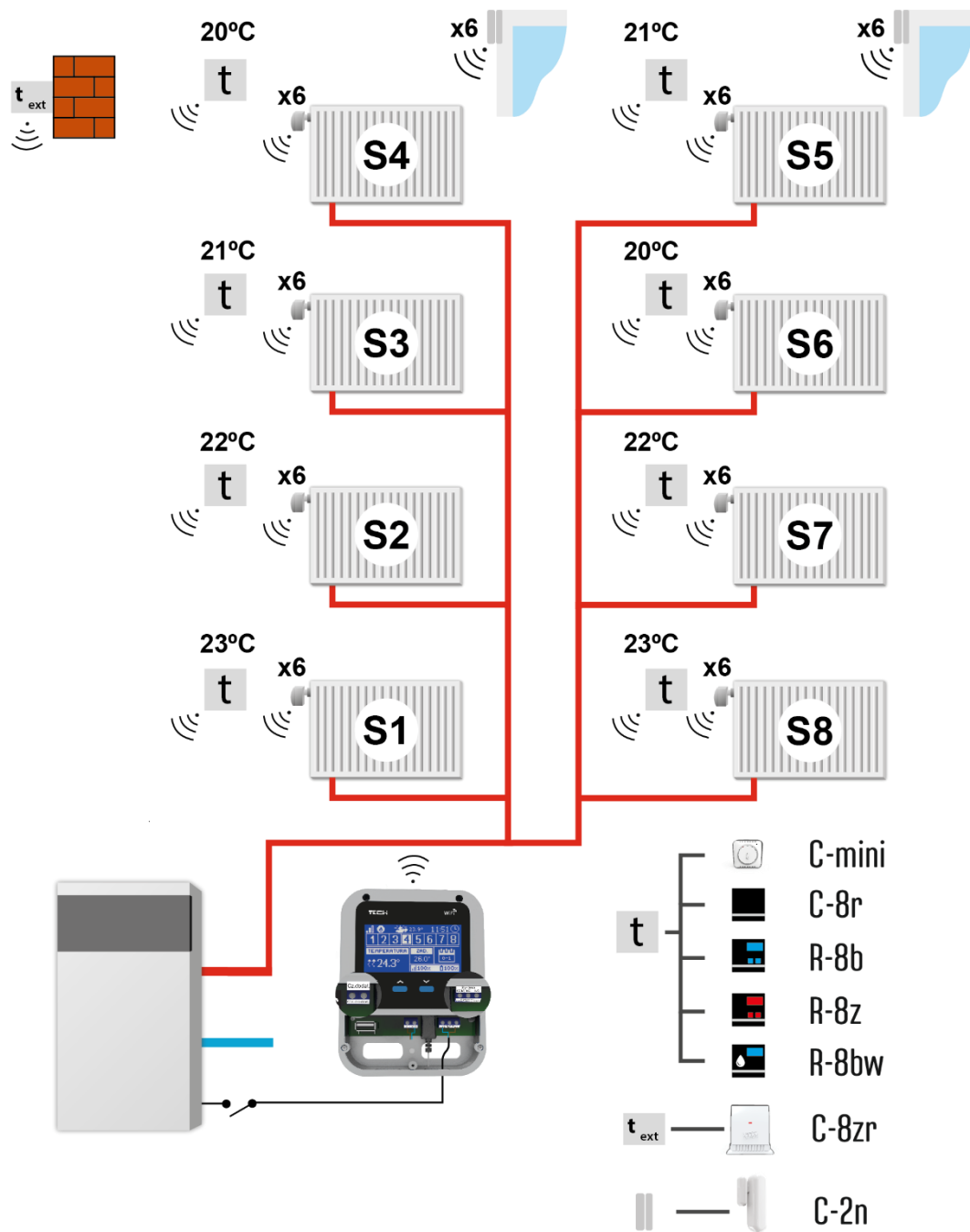

S1 Zone – built-in temperature sensor (controlling up to 6 x STT-868, STT-869 with software version 2.1.8 and later) or wireless

S2 Zone – wired temperature sensor (controlling up to 6 x STT-868, STT-869 with software version 2.1.8 and later) or wireless

S3-S8 Zone – wireless temperature sensor (controlling up to 6 x STT-868, STT-869 with software version 2.1.8 and later).

V. FIRST START-UP

In order for the controller to work properly, follow these steps while starting it for the first time:

1. Configure the Internet connection
2. Configure the external sensor (optional)
3. Configure the room sensors, room regulators
4. Configure wireless thermostatic actuators STT-868/STT-869 (with controller version 2.1.8 and later)
5. Configure window sensors (optional)

1. HOW TO CONFIGURE INTERNET CONNECTION

EU-WiFi 8s has a built-in Internet module, which enables the user to control the heating system via the Internet. First, connect to the Internet by selecting your WiFi network in Menu > WiFi network selection. Such parameters as IP Address, IP Mask, Gate Address may be set manually or it is possible to activate DHCP option (enabled by default).

Next, go to www.emodul.eu and create your account. After selecting <Registration> in the controller menu, the system generates a code which must be entered in <Settings> tab of the emodul.eu website (Register module).

2. HOW TO CONFIGURE EXTERNAL SENSOR

It is necessary to register the external sensor by selecting <Registration> in the EU-WiFi 8s controller (Main menu > External sensor > Registration) and pressing the communication button on the external sensor (press the button briefly once).

The registration process enables the external sensor automatically. Once registered, the sensor may be switched off at any time by selecting <OFF> .

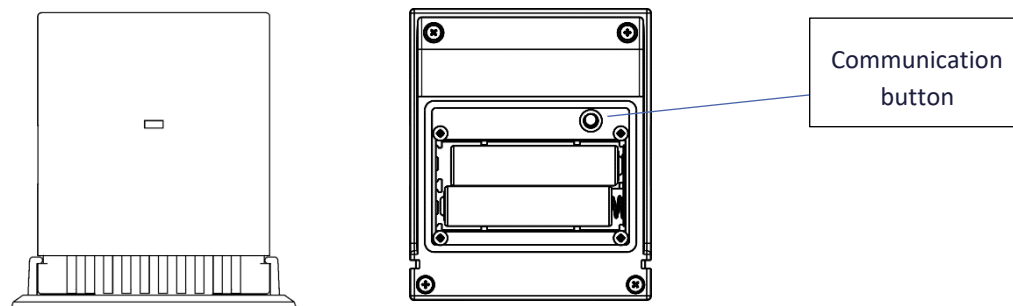

NOTE

- The external sensor is not involved in the control process.
- Switching the sensor off in the external sensor menu only interrupts the communication (the external temperature is no longer displayed on the external controller screen). It does not disable the external sensor itself – it remains active until the battery is flat.

3. HOW TO CONFIGURE TEMPERATURE SENSORS AND ROOM REGULATORS

To enable EU-WiFi 8s to control a given zone, it is necessary to provide it with current temperature value. The easiest way is to use C-8r or C-mini temperature sensor. If the user wants to be able to change the pre-set temperature value directly from the zone, it is advisable to use R-8b, R-8z or R-8bw room regulator (software version 2.1.19 and later). Regardless of the type of temperature sensor / room regulator chosen, it must be registered in a particular zone in the EU-WiFi 8s controller menu.

In order to register the sensor/room regulator, go to the submenu of a given zone and select Registration (Zone / Registration). Next, press the communication button which can be found on the back of the selected temperature sensor/room regulator (in the case of C-8r, C-mini, R-8b, R-8z and R-8bw (software version 2.1.19 and later), press the

button once briefly). If the process has been completed successfully, the EU-WiFi 8s controller display shows an appropriate message. Otherwise, the process must be conducted again.



NOTE

Only one room sensor may be assigned to each zone.

Zone 1 is the zone where EU-WiFi 8s is installed - its operation is based on the readings from the built-in sensor.

Zone 2 uses readings from the wired temperature sensor connected to the EU-WiFi 8s controller. The user may change the sensor type to wireless in these zones in the zone MENU (MENU -> Zones -> Zone 1 -> Type of sensor).

The following rules must be kept in mind:

- Only one temperature sensor may be registered in each zone.
- Once registered, the sensor cannot be unregistered, but only switched off by selecting OFF in the submenu of a given zone.
- If the user attempts to assign a sensor to the zone to which other sensor has already been assigned, the first sensor becomes unregistered and it is replaced by the other one.
- If the user attempts to assign a sensor which has already been assigned to a different zone, the sensor is unregistered from the first zone and registered in the other one.

It is possible to set individual pre-set temperature value and a weekly schedule for each room sensor assigned to a given zone. The pre-set zone temperature may be adjusted in the controller menu (Main menu / Zones). Weekly schedule settings and the pre-set values may be configured via www.emodul.eu

4. HOW TO CONFIGURE WIRELESS THERMOSTATIC ACTUATORS STT-868/STT-869 (SOFTWARE VERSION 2.1.8 AND LATER)

The next step involves registering a given actuator in the zone.



NOTE

The maximum of 6 actuators may be registered in each zone.

Registration process:

1. Install the thermostatic actuator on the radiator and wait until it calibrates.
2. Go to EU-WiFi 8s menu, select the zone number where the actuator is to be registered and select Actuators/Registration.
3. Press the registration button on the actuator within 120 seconds from selecting Registration option. After this time EU-WiFi 8s considers the registration attempt as unsuccessful.
4. If the registration process has been completed successfully, the display shows an appropriate message. In case of any errors, the display shows an appropriate message. There are 2 possible causes of errors in the registration process:
 - an attempt to register more than 6 actuators
 - no signal from the valve actuator within the period of 120 seconds







5. HOW TO CONFIGURE WINDOW SENSORS



In order to register the window sensor, select 'Registration' (Main menu ->) and press briefly the communication button on the window sensor. Release the button and watch the control light:

- control light flashes twice - proper communication established
- control light lights up continuously - no communication with the main controller

VI. WIRELESS COMMUNICATION

The EU-WiFi 8s controller may communicate wirelessly with certain devices:

	Device	Function	Configuration
	C-8r room temperature sensor	- sending current room temperature readings	The sensor should be registered in a given zone.
	C-mini room temperature sensor	- sending current room temperature readings	The sensor should be registered in a given zone.
	R-8b a two-state room regulator power supply: 2xAAA 1,5V	- sending current zone temperature readings - adjusting the pre-set temperature value directly from the zone	Register the room regulator in one of the zones.
	R-8bw a two-state room regulator power supply: 2xAAA 1,5V	- sending current zone temperature data - adjusting pre-set temperature directly from the zone - built-in humidity sensor	The room regulator should be registered in a given zone.
	R-8z a two-state room regulator power supply: 230V 50Hz	- sending current zone temperature data - adjusting pre-set temperature directly from the zone	The room regulator should be registered in a given zone.
	C-7p wired room sensor	- sending current room temperature readings	
	C-8zr external temperature sensor	- sending current external temperature data to EU-WiFi 8s controller	The sensor should be registered in EU-WiFi 8s controller.

	STT-868 wireless thermostatic actuator	- opening/closing the valve in order to maintain desired temperature value	The actuator should be registered in a given zone.
	STT-869 wireless thermostatic actuator	- opening/closing the valve in order to maintain desired temperature value	The actuator should be registered in a given zone.
	C-2n window sensor	- sending a signal to the main controller informing about window opening/closing	Install the sensor on a window and register it in the zone.

VII. MAIN SCREEN DESCRIPTION

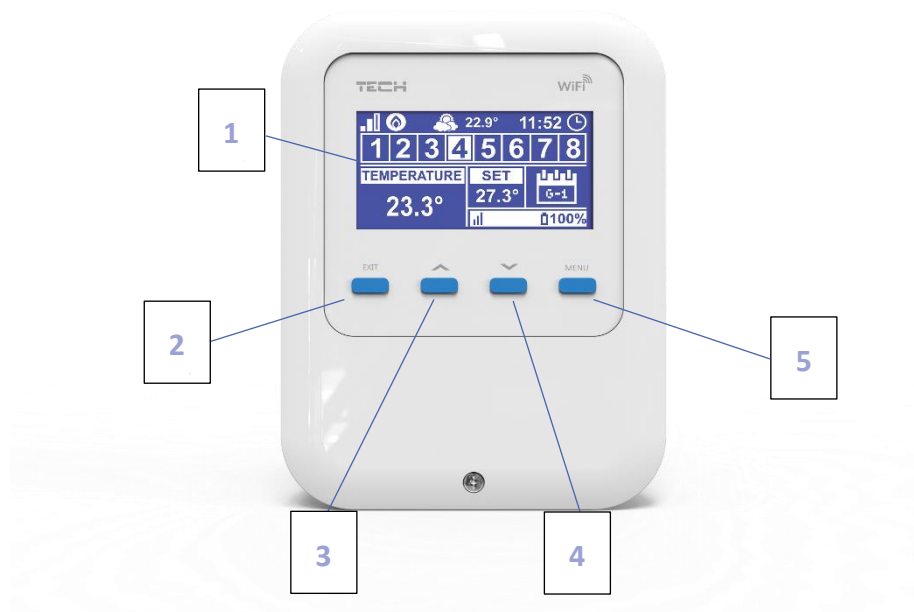

1. Display
2. EXIT – in the main screen view it is used to open up the screen view selection submenu. In the controller menu it is used to cancel the settings and exit the submenu.
3. PLUS – in the main screen view it is used to view the status of the next zone. In the controller menu it is used to view the controller functions and increase the value while editing parameters.
4. MINUS - in the main screen view it is used to view the status of the previous zone. In the controller menu it is used to view the controller functions and decrease the value while editing parameters.
5. MENU – it is used to enter the controller menu and confirm the new settings

➤ MAIN SCREEN DESCRIPTION – ZONES

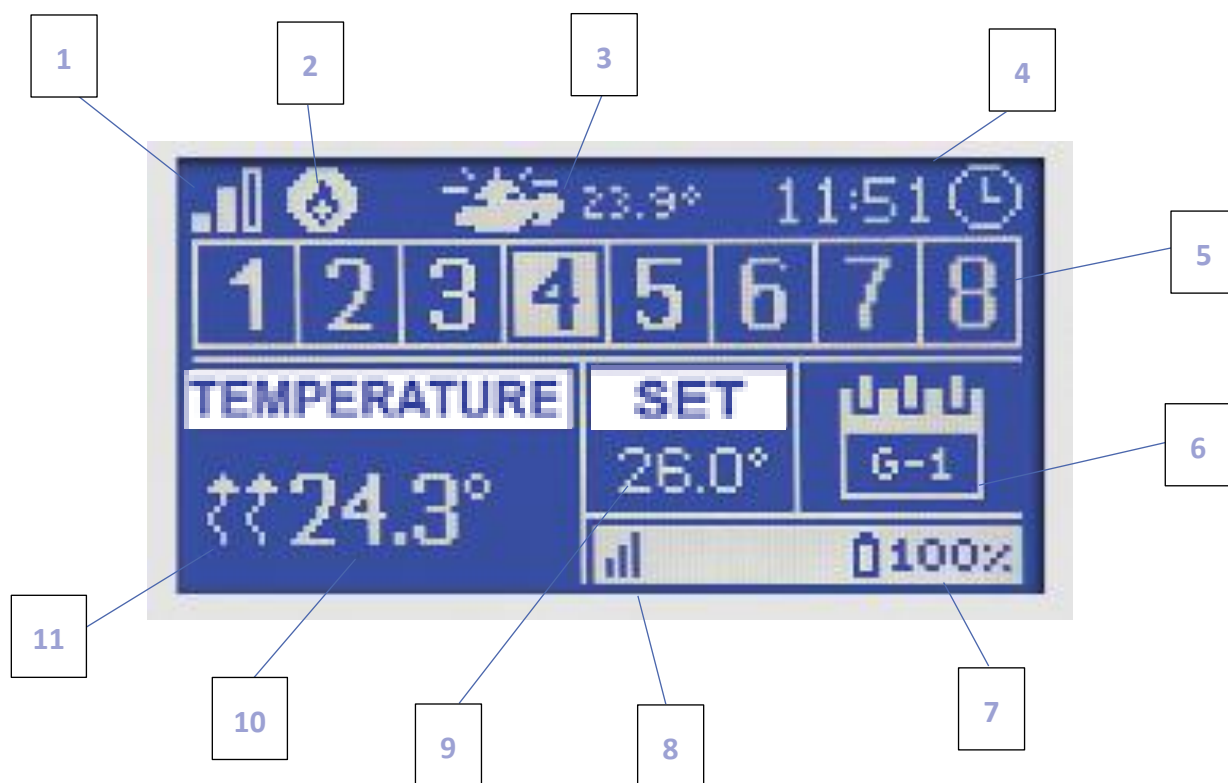

1. WiFi signal strength
2. Additional device icon – displayed when the device is switched on.
3. External temperature
4. Current time
5. Zone information:
The displayed digit represents the room sensor sending current temperature readings from a given zone. In case of an alarm in a given zone, the screen displays an appropriate message. If the digit is flashing, the corresponding zone needs heating.
In order to view current operating parameters of a given zone, highlight its number using PLUS or MINUS buttons. If a window icon is displayed instead of a digit, it means that a window in the zone is open and the heating is disabled.
6. The type of current weekly schedule or Time left before the next change of manually-set zone temperature
7. Level of battery in the C8-r or C-mini room sensor or in the room regulator (R-8b, R-8bw) in a given zone (highlighted number in the zone information bar – see: description no 5).
8. Signal strength of the C8-r or C-mini room sensor or the room regulator R-8b, R-8z, R-8bw (software version 2.1.19 and later) in a given zone (highlighted number in the zone information bar – see: description no 5).
9. Pre-set zone temperature (highlighted number in the zone information bar – see: description no 5).
10. Current zone temperature (highlighted number in the zone information bar – see: description no 5).
11. An icon indicating active heating in a given zone (highlighted number in the zone information bar – see: description no 5).

➤ MAIN SCREEN DESCRIPTION – WIFI

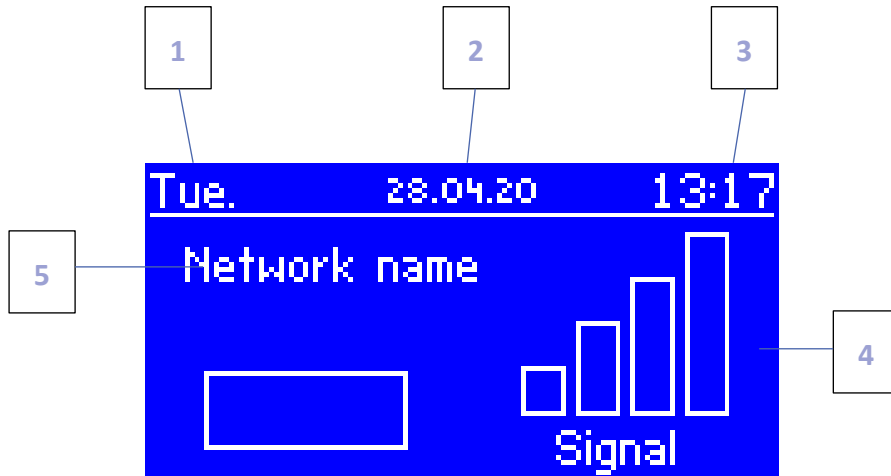

1. Day of the week
2. Current date
3. Current time
4. Signal strength
5. WiFi network name

➤ MAIN SCREEN DESCRIPTION - ZONE 1

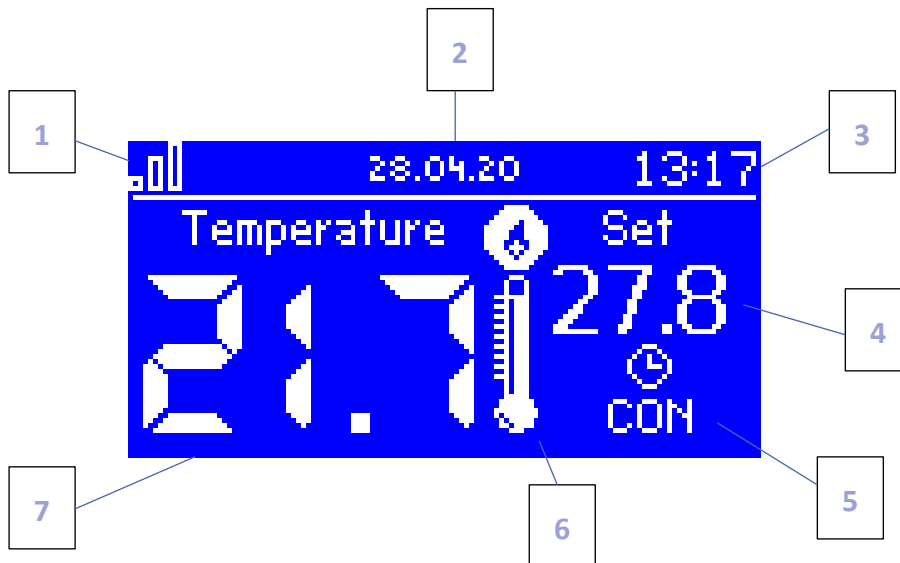

1. WiFi signal strength
2. Current time
3. Current date
4. Pre-set zone temperature
5. Time left before the next change of the pre-set temperature
6. Additional device icon – displayed when the device is switched on.
7. Current room temperature

VIII. CONTROLLER FUNCTIONS

1. BLOCK DIAGRAM - CONTROLLER MENU

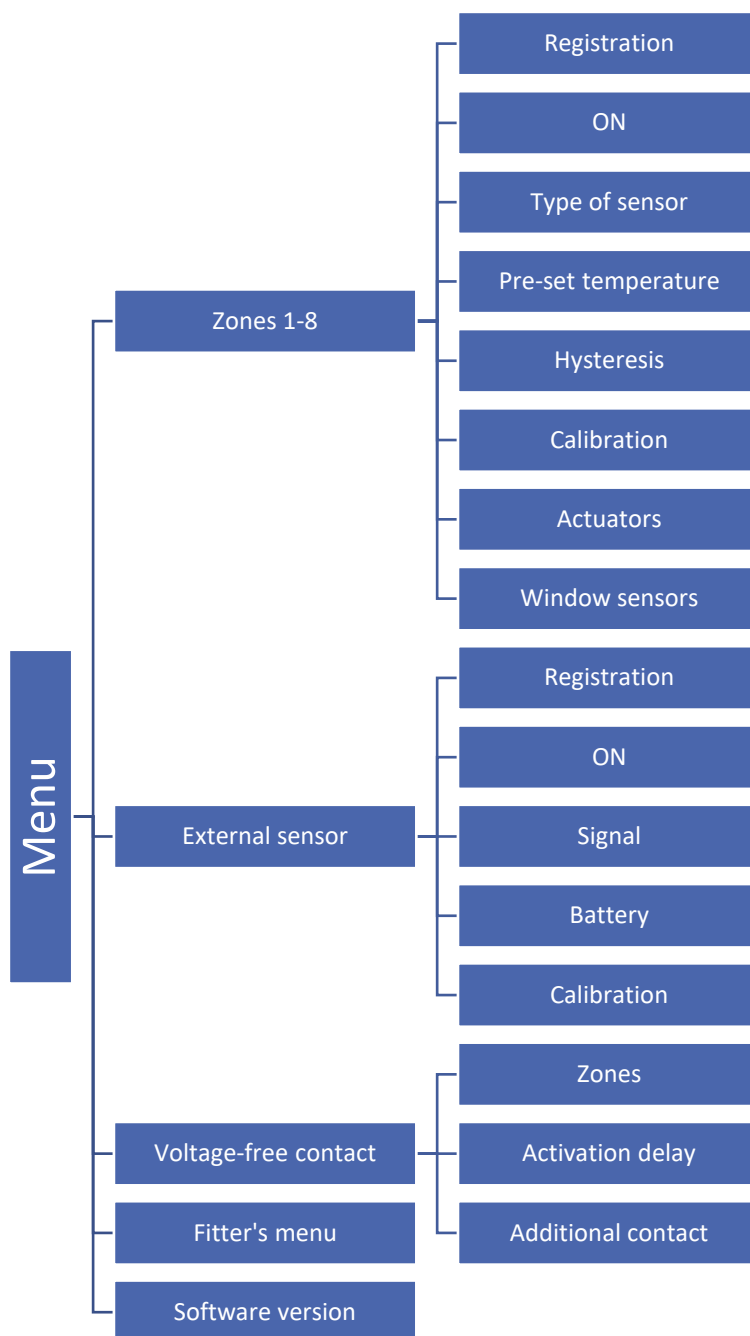

2. ZONES

This submenu enables the user to configure operation parameters for particular zones.

2.1. REGISTRATION

The Registration function is available for zones 3-8 and zones 1-2 if wireless sensor type has been selected.

Once the room sensor has been switched on and registered in a given zone, its readings are used by the EU-WiFi 8s controller. The sensor may be disabled by deselecting ON.

2.2. ON

Once the room sensor has been switched on and registered in a given zone, its readings are used by the EU-WiFi 8s controller. The sensor may be disabled by deselecting ON.

2.3. TYPE OF SENSOR

This option is available for zones 1 and 2. The user chooses the sensor type between internal sensor (built-in or wired sensor) and wireless sensor.

2.4. PRE-SET TEMPERATURE

The pre-set zone temperature depends on the weekly schedule settings. However, this function enables the user to change this value separately - it is necessary to deactivate the schedule. The user may set constant temperature or for a pre-defined period of time.

2.5. HYSTERESIS

This function is used to define tolerance of the pre-set temperature in order to prevent undesired oscillation in case of small temperature fluctuation (within the range $0,1 \div 10^{\circ}\text{C}$) with the accuracy of $0,1^{\circ}\text{C}$.

Example: if the pre-set temperature is 23°C and the hysteresis is $0,5^{\circ}\text{C}$, the zone temperature is considered too low when it drops to $22,5^{\circ}\text{C}$.

2.6. CALIBRATION

Room sensor calibration is performed while mounting or after it has been used for a long time, if the zone temperature displayed differs from the actual temperature. Calibration range is from -10°C to $+10^{\circ}\text{C}$ with the accuracy of $0,1^{\circ}\text{C}$.

2.7. ACTUATORS

This submenu is used to configure the operation of thermostatic actuators STT-868 or STT-869 (controller version 2.1.8 and later). In each zone it is possible to register up to 6 actuators STT-868 or STT-869 (controller version 2.1.8 and later). The registration process is described in detail in First start-up section. In order to unregister all actuators from a given zone, select **Actuator removal function**.

From 1.1.0 actuator software version on, it is possible to identify, monitor status or remove single actuators. In order to do it, press the button on the actuator and hold it for about 2 seconds until EU-WiFi 8s display shows an information panel.

SETTINGS – FROM VERSION 2.1.34

The Settings submenu enables the user to configure the operation of thermostatic actuators. It is possible to define the maximum and minimum actuator opening – these levels of valve opening and closing will never be exceeded.

Range - parameter which specifies the room temperature at which the valve starts opening and closing.

SIGMA function allows for smooth control of the thermostatic valve. Once the function has been activated, the user may also define **the minimum and maximum level of valve closing**.

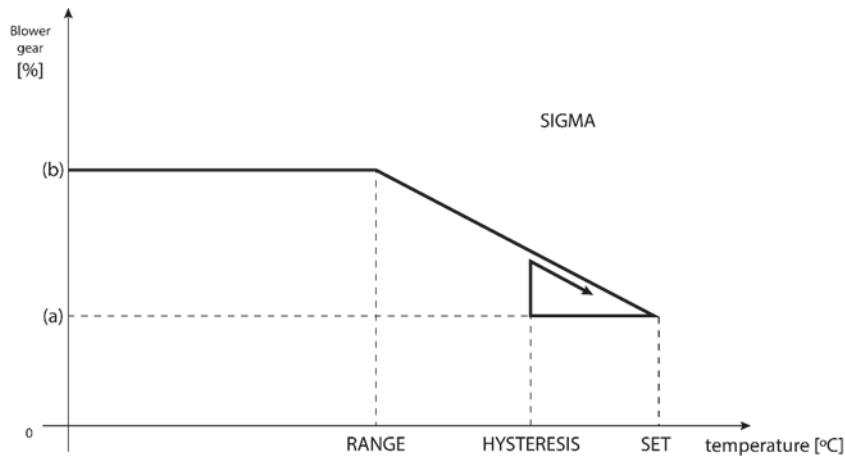

(a) - min. opening
 (b) - Actuator opening
 ZAD - set temperature

Example:

Pre-set zone temperature: 23°C

Minimum opening: 30%

Maximum opening: 90%

Range: 5°C

Hysteresis: 2°C

In the above example, the thermostatic valve starts closing at the temperature of 18°C (pre-set value minus Range: 23-5). The **minimum opening** is reached when the zone temperature reaches the pre-set value.

After reaching the pre-set value, the temperature starts falling. At the temperature of 21°C (pre-set value minus hysteresis: 23-2) the valve starts opening. The **maximum opening** is reached at the temperature of 18°C.

Protection - If the pre-set temperature is exceeded by the number of degrees specified in the <range> parameter, all actuators in a given zone will be closed (0% opening). This function works only when the SIGMA function is enabled.

Emergency mode – This function enables the user to define the actuator opening which will be forced in the event of an alarm in a given zone (sensor failure, communication error). The emergency mode of thermoelectric actuators is enabled in the event of power loss in the EU-WiFi controller.

2.8. WINDOW SENSORS

- **Registration** – In order to register the sensor, select 'Registration' and press quickly the communication button on the window sensor. Release the button and watch the control light:
 - the control light flashes twice - proper communication established
 - the control light lights up continuously - no communication with the main controller
- **Sensor removal** – this function is used to remove the sensors in a given zone
- **Information** – this option is available only when the sensor is registered. It enables the user to view all the sensors and check their range and battery level.

- **Settings** – this function is used to set the delay time. When the pre-set delay time is over, the main controller sends the information to the actuators forcing them to close. The time setting range is 0-30 minutes.

Example: Delay time is set at 10 minutes. When the window is opened, the sensor sends the information to the main controller. If the sensor sends another information that the window is open after 10 minutes, the main controller will force the actuators to close and disable the heating in the given zone.

NOTE



If the delay time is set at 0 minutes, the message forcing the actuators to close will be sent immediately.

3. EXTERNAL SENSOR

It is possible to connect an external temperature sensor to the controller. The device enables the user to monitor current temperature on the main screen as well as via emodul.eu application. The external sensor is not involved in the control process.

Once the external sensor has been installed, it must be registered in the EU-WiFi 8s controller – the registration process is described in detail in First start-up section.

4. VOLTAGE-FREE CONTACT

4.1. ZONES

This menu enables the user to select the zone which will influence the operation of the built-in voltage-free contact. If a given zone is not selected, its status is ignored by the controller and the voltage-free contact is not activated if the temperature in this zone is too low.

4.2. ACTIVATION DELAY

The controller activates the additional contact after the delay time if the temperature in any of the zones is below the pre-set value. The controller disables the contact after the pre-set temperature has been reached.

4.3. ADDITIONAL CONTACT

This function enables the user to register the MW-1 module (voltage-free contact) and MW-1-230V (voltage contact).

In order to register a module, follow these steps:

- press the registration button on the module
- select 'Registration' in the EU-WiFi 8s controller

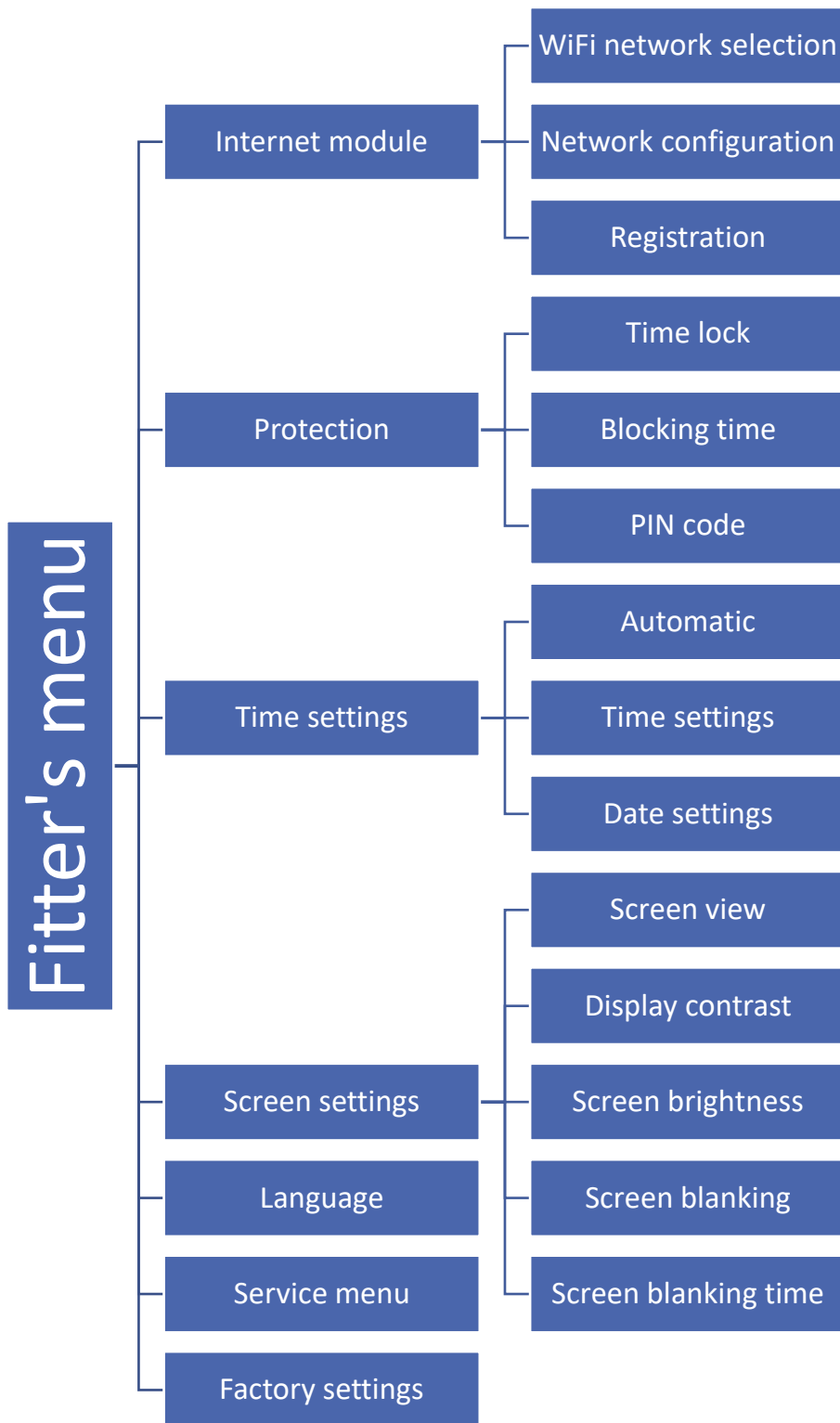

Required network settings

For the Internet module to work properly, it is necessary to connect the module to the network with a DHCP server and an open port 2000.

After connecting the Internet module to the network, go to the module settings menu (in the master controller).

If the network does not have a DHCP server, the Internet module should be configured by its administrator by entering appropriate parameters (DHCP, IP address, Gateway address, Subnet mask, DNS address).

1. Go to the Internet module settings menu.
2. Select "ON".
3. Check if the "DHCP" option is selected.
4. Go to "WIFI network selection"
5. Select your WIFI network and enter the password.
1. Wait for a while (approx. 1 min) and check if an IP address has been assigned. Go to the "IP address" tab and check if the value is different from 0.0.0.0 / -.-.-.-.
 - a) If the value is still 0.0.0.0 / -.-.-.-, check the network settings or the Ethernet connection between the Internet module and the device.
2. After the IP address has been assigned, start the module registration in order to generate a code which must be assigned to the account in the application.

- **WIFI NETWORK SELECTION**

This submenu offers a list of available networks. Select the network and confirm by pressing MENU. If the network is secured, it is necessary to enter the password. Use + and – to select each letter of the password and press EXIT to complete the procedure.

- **NETWORK CONFIGURATION**

Normally, the network is configured automatically. The user may also conduct it manually using the following parameters of this submenu: DHCP, IP address, Subnet mask, Gate address, DNS address and MAC address.

- **REGISTRATION**

Select Registration in order to generate the code necessary to register the EU-WiFi 8s controller at <https://emodul.eu> – see: First start-up.

This function is used to change the parental lock settings. After activating the 'Time lock' function, the screen will lock after the time set in the 'Lock time' parameter. The user can set a PIN code which will be requested before entering the controller menu.



NOTE

Default PIN code is 0000.

The controller downloads current time and date from the network. The user may also set the time and date manually.

5.4. SCREEN SETTINGS

The parameters available in this submenu enable the user to customize the main screen view. It is possible to select the parameters to be displayed: WiFi (the screen displays the network name and signal strength) or Zones (the screen displays current and pre-set values in particular zones).

The user may also adjust the display contrast as well as the screen brightness. The screen blanking function enables the user to adjust the brightness of a blank screen. Screen blanking time defines the idle time after which the screen goes blank.

5.5. LANGUAGE

This function is used to select the language version of the controller menu.

5.6. SERVICE MENU

The parameters available in the service menu should be configured only by qualified fitters and access to this menu is secured with a code.

5.7. FACTORY SETTINGS

This function is used to restore factory settings of the parameters in the main menu (excluding the service menu).



NOTE

After selecting this function it will be necessary to configure the Internet connection. If this function has been activated, all registered devices are removed from the device memory.

6. SOFTWARE VERSION

This function is used to view the controller software version.

IX. HOW TO CONTROL THE HEATING SYSTEM ONLINE

Our website www.emodul.eu offers multiple tools for controlling your heating system. In order to take full advantage of the technology, create your own account:

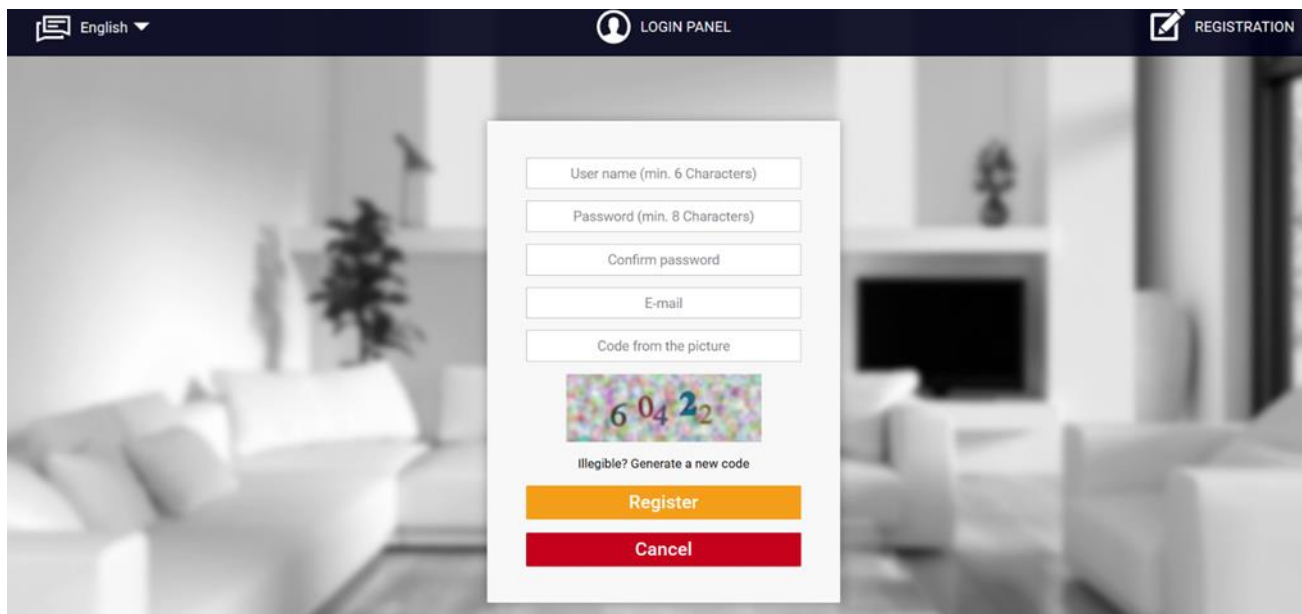

The screenshot shows the registration form on the website. The form is centered on a blurred background of a living room. At the top, there is a navigation bar with 'English' on the left, 'LOGIN PANEL' in the center, and 'REGISTRATION' on the right. The registration form itself has the following fields: 'User name (min. 6 Characters)', 'Password (min. 8 Characters)', 'Confirm password', 'E-mail', and 'Code from the picture'. Below the 'Code from the picture' field is a CAPTCHA image showing the numbers '6 0 4 2 2'. Underneath the CAPTCHA is the text 'Illegible? Generate a new code'. At the bottom of the form are two buttons: an orange 'Register' button and a red 'Cancel' button.

Registering a new account at www.emodul.eu

Once logged in, go to Settings tab and select Register module. Next, enter the code generated by the controller (to generate the code, select Registration in the EU-WiFi 8s controller menu). The module may be assigned a name (in the field labelled Module description).

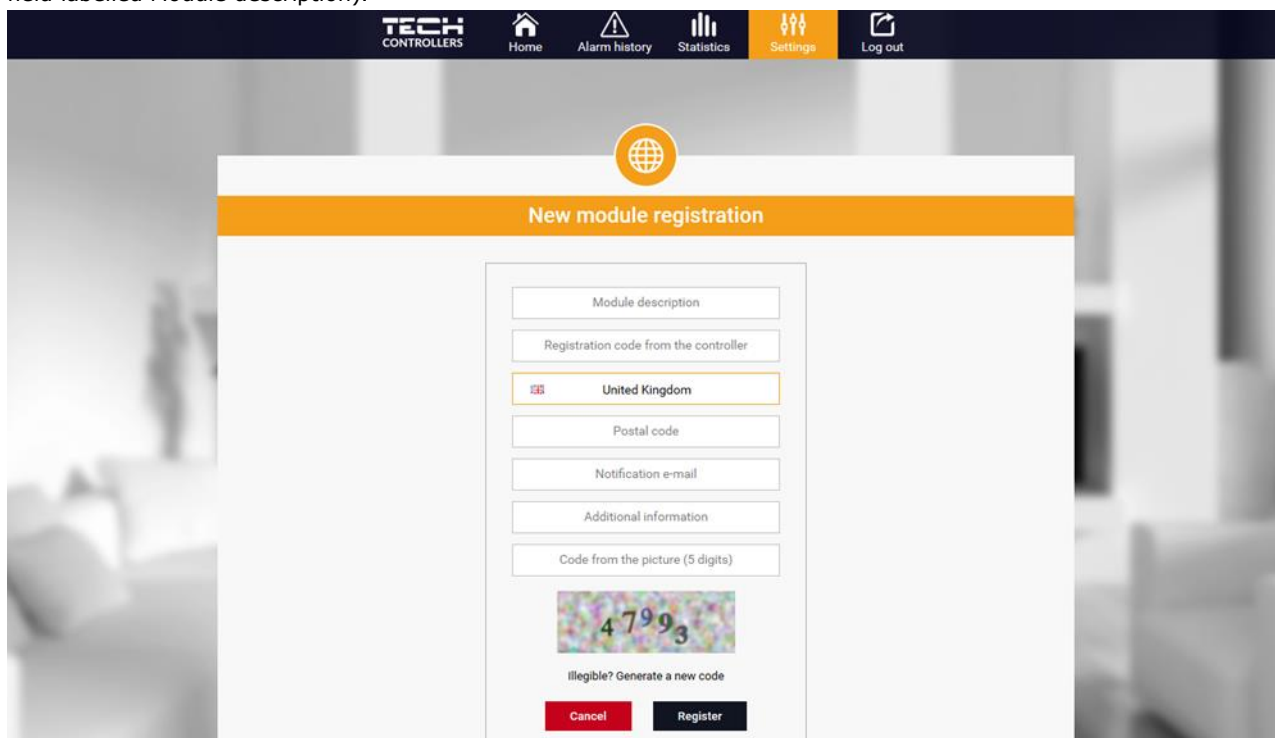

The screenshot shows the 'New module registration' form on the website. The form is centered on a blurred background of a living room. At the top, there is a navigation bar with 'TECH CONTROLLERS' on the left, and 'Home', 'Alarm history', 'Statistics', 'Settings', and 'Log out' on the right. The 'New module registration' form has the following fields: 'Module description', 'Registration code from the controller', a dropdown menu for 'United Kingdom', 'Postal code', 'Notification e-mail', 'Additional information', and 'Code from the picture (5 digits)'. Below the 'Code from the picture' field is a CAPTCHA image showing the numbers '4 7 9 9 3'. Underneath the CAPTCHA is the text 'Illegible? Generate a new code'. At the bottom of the form are two buttons: a red 'Cancel' button and a black 'Register' button.

Registering a new module

1. HOME TAB

Home tab displays the main screen with tiles illustrating the current status of particular heating system devices. Tap on the tile to adjust the operation parameters:

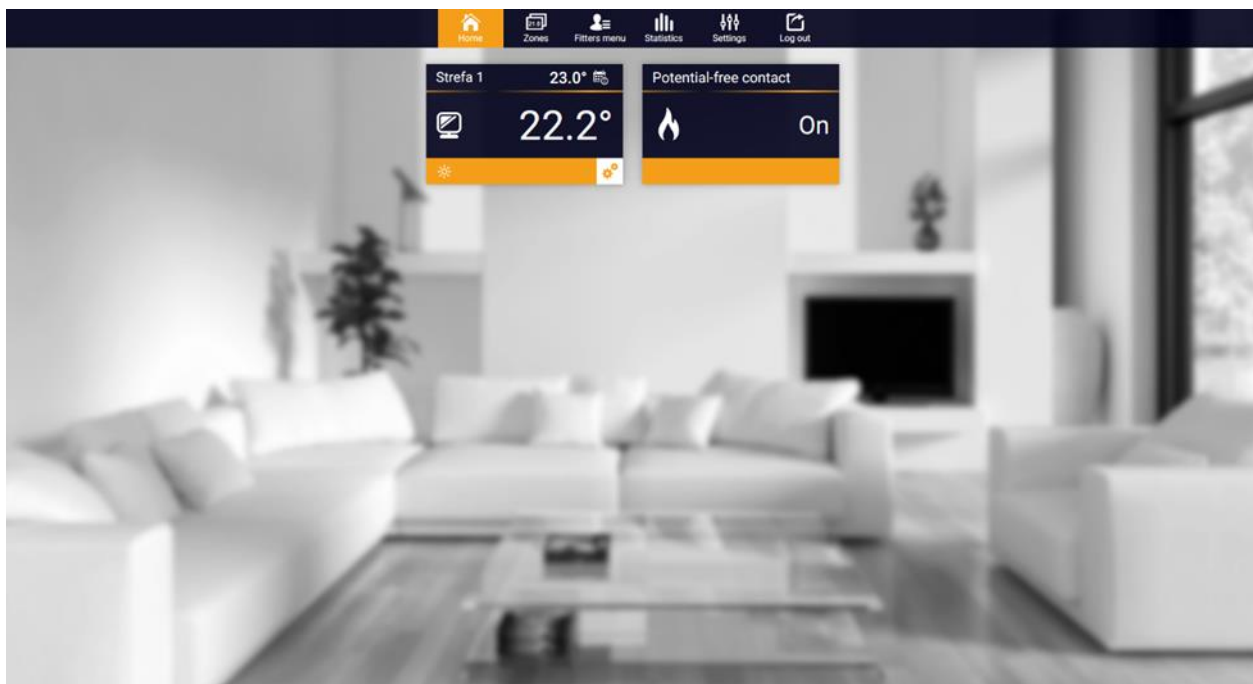

HOME tab

NOTE



'No communication' message means that the communication with the temperature sensor in a given zone has been interrupted. The most common cause is the flat battery which needs replacing.

Tap on the tile corresponding to a given zone to edit its pre-set temperature:

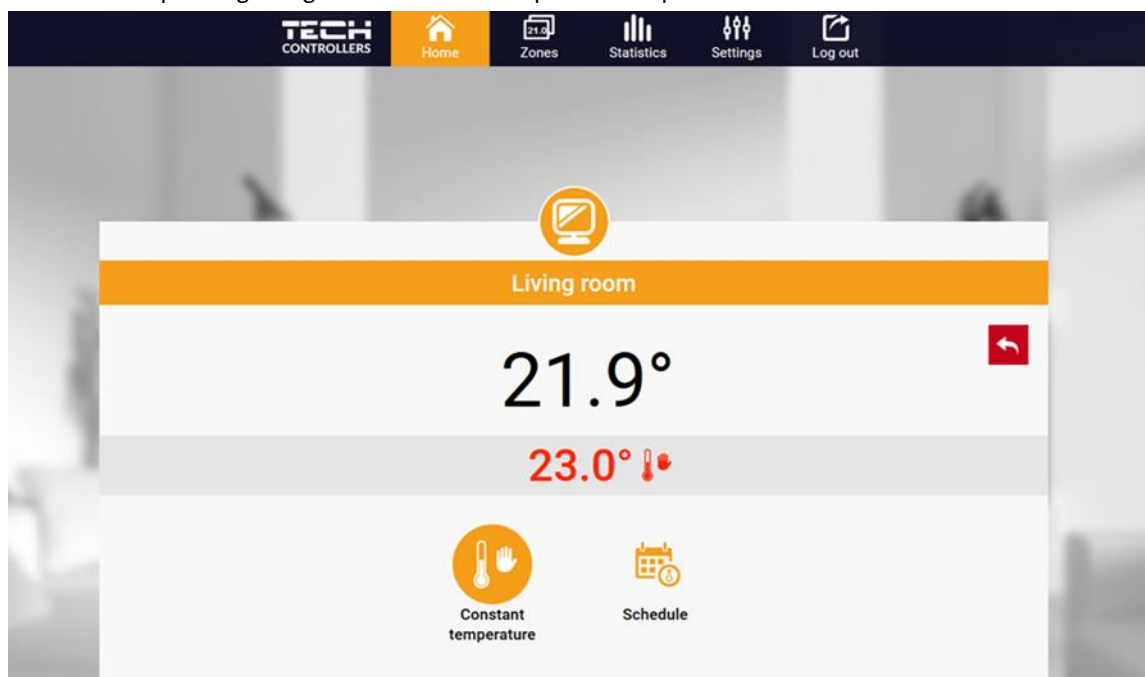

Editing the pre-set temperature

The upper value is the current zone temperature whereas the bottom value is the pre-set temperature. The pre-set zone temperature depends by default on the weekly schedule settings. Constant temperature mode enables the user to define a separate pre-set temperature value which will apply in the zone regardless of the time.

Selecting Constant temperature it is possible to set time limits.

This mode enables the user to set the temperature value which will apply only within a pre-defined period of time. When the period is over, again the pre-set temperature depends on the previous weekly schedule settings (schedule or constant temperature without time limit).

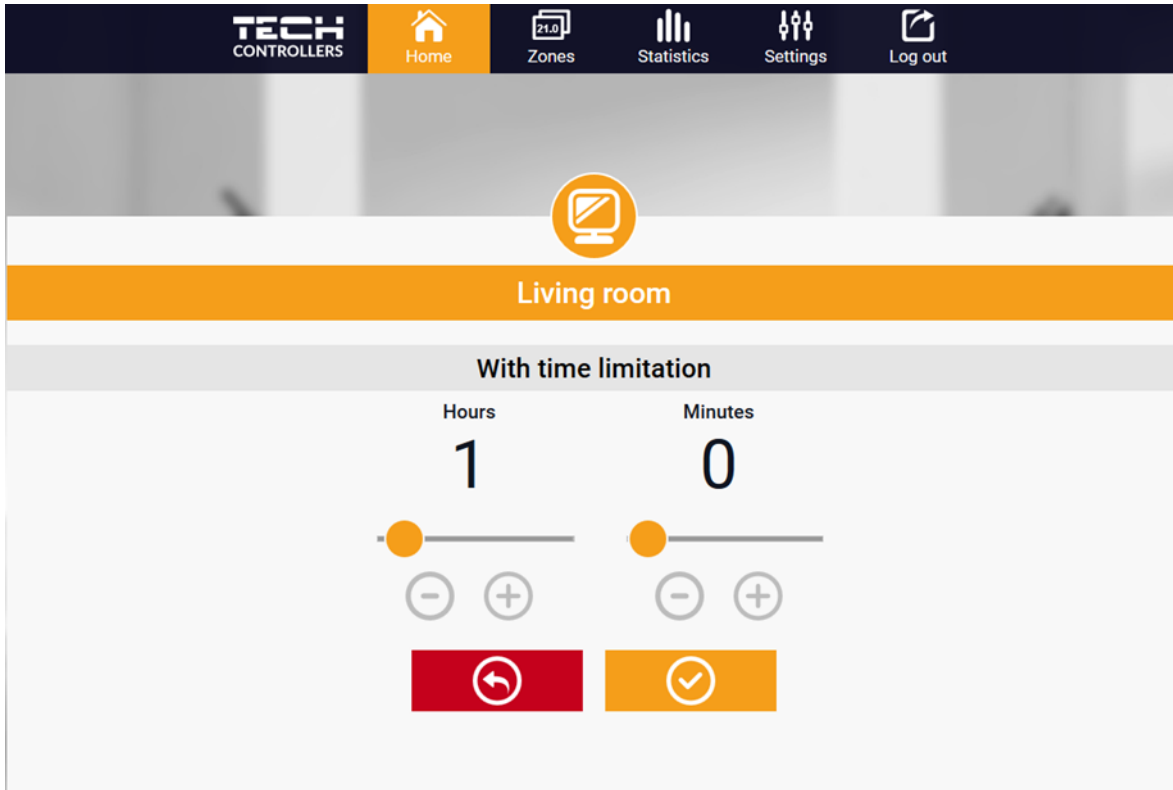

Pre-set temperature with time limit

Tap on Schedule icon to open up the schedule selection screen:

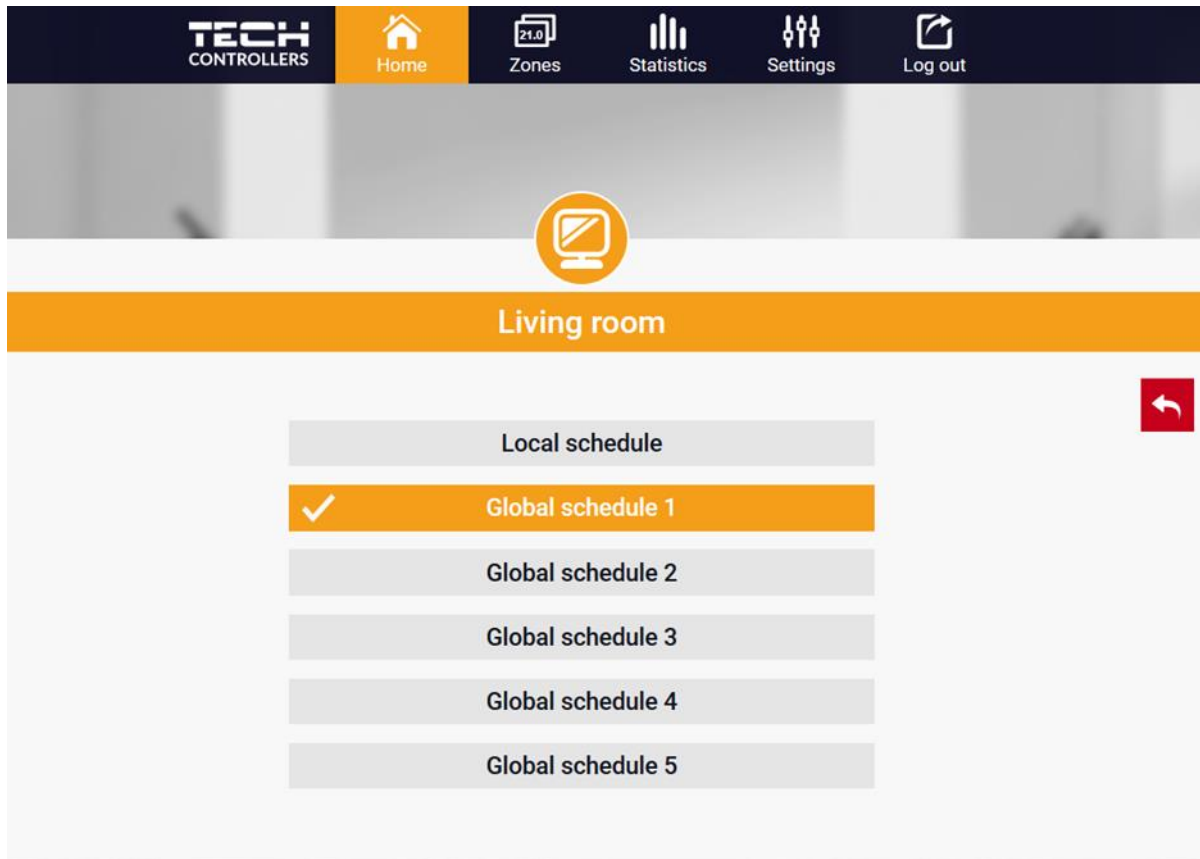

Selecting a weekly schedule

Two types of weekly schedules are available in the EU-WiFi 8s controller:

1. Local schedule

It is a weekly schedule assigned to a particular zone. Once the EU-WiFi 8s controller detects the room sensor, the schedule is assigned automatically to the zone. It may be edited by the user.

2. Global schedule (Schedule 1..5)

Global schedule may be assigned to any number of zones. The changes introduced in the global schedule apply to all zones where the global schedule has been activated.

After selecting the schedule tap on OK and move on to edit the weekly schedule settings:

TECH CONTROLLERS Home Zones Statistics Settings Log out

Living room

Local schedule

Mo Tu We Th Fr Sa Su

Setback temperature

23.0°

00:00 - 06:00	20.0°	=
08:00 - 16:00	18.5°	=
23:00 - 00:00	20.0°	=

Mo Tu We Th Fr Sa Su

Set temperature

23.0°

00:00 - 07:00	20.0°	=
23:00 - 00:00	20.0°	=

+

⏪ ⏩

Editing a weekly schedule

Editing enables the user to define two programs and select the days when the programs will be active (e.g. from Monday to Friday and the weekend). The starting point for each program is the pre-set temperature value. For each program the user may define up to 3 time periods when the temperature will be different from the pre-set value. The time periods must not overlap. Outside these time periods the pre-set temperature will apply. The accuracy of defining the time period is 15 minutes.

2. ZONES TAB

The user may customize the home page view by changing zone names and the corresponding icons. In order to do it, go to Zones tab.

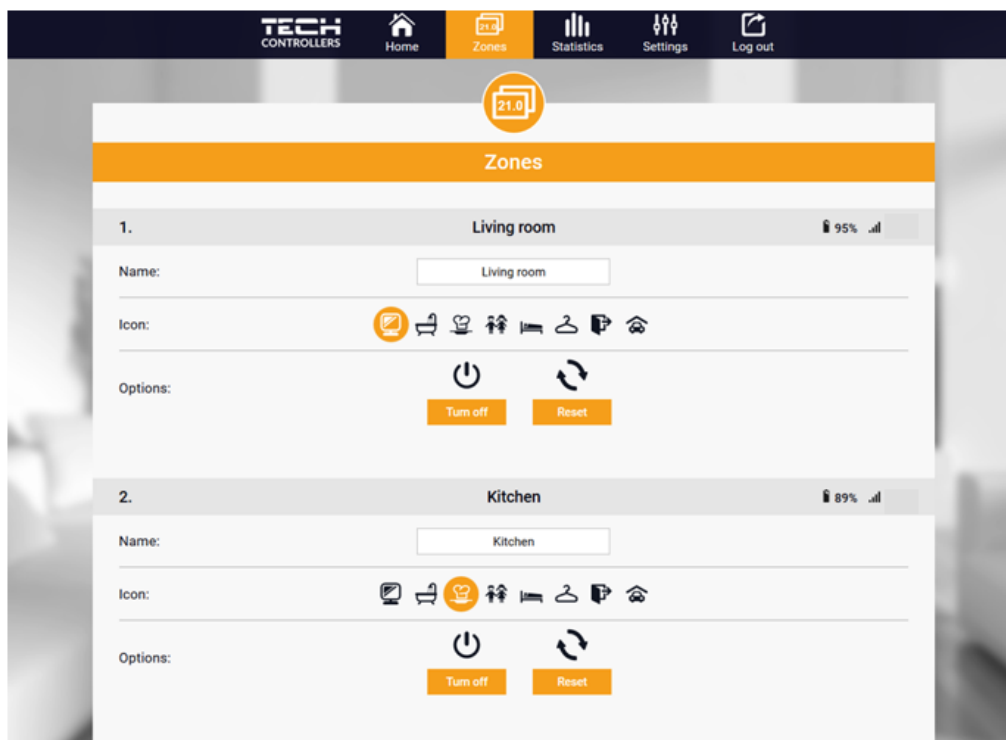

Zones tab

3. STATISTICS TAB

The Statistics tab enables the user to view the temperature charts for different time periods e.g. 24h, a week or a month. It is also possible to view the statistics for the previous months:



An example chart

4. SETTINGS TAB

The *Settings* tab enables the user to register a new module and change the e-mail address or the password:

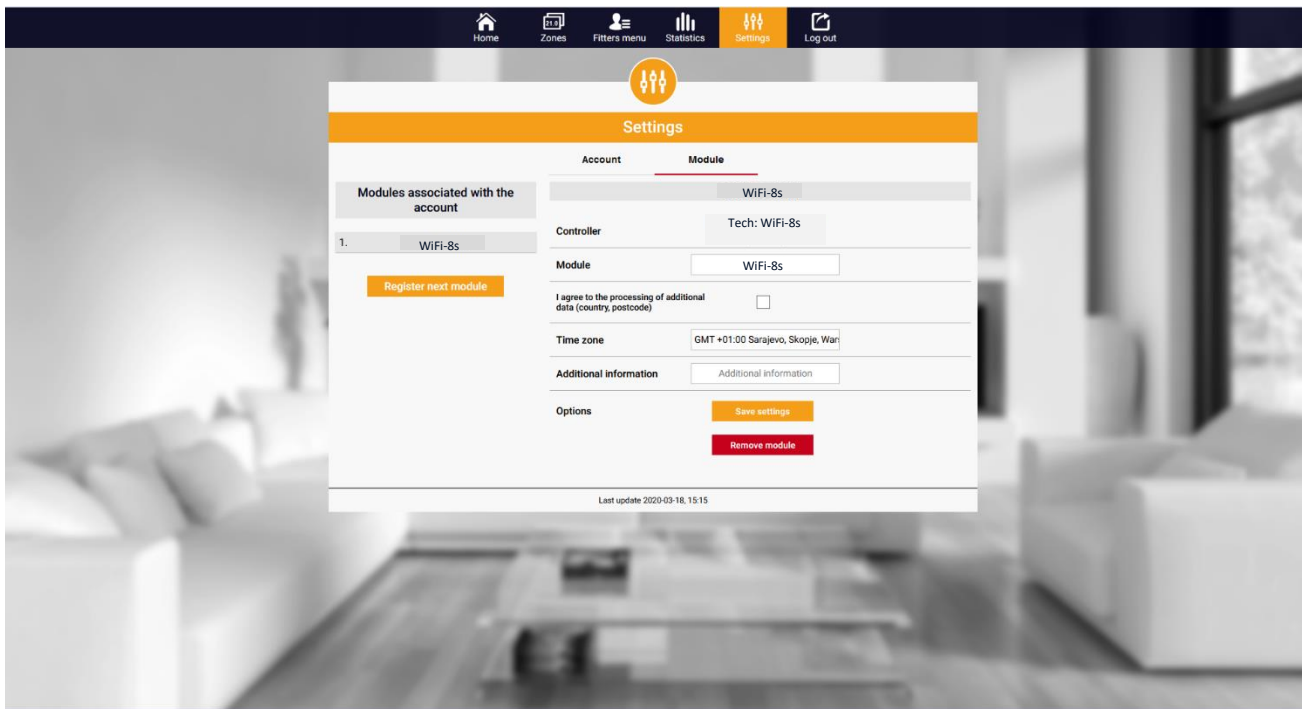

Settings/Module tab

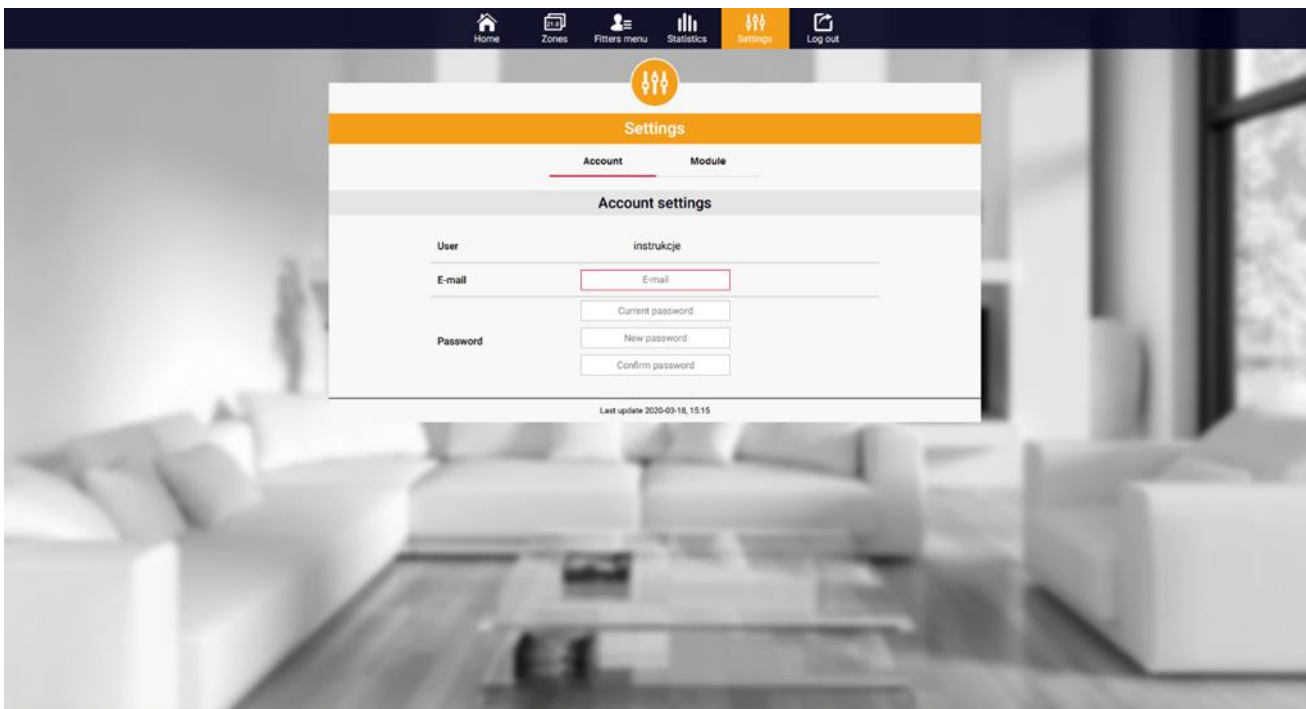

Settings/Account tab

X. SOFTWARE UPDATE



NOTE

Software update shall be conducted only by a qualified fitter. After the software has been updated, it is not possible to restore previous settings.

In order to install new software, the controller must be unplugged from the power supply. Next, insert the flash drive with the new software into the USB port. Switch the controller on. After the software update has been completed, the controller restarts automatically.



NOTE

Do not switch the controller off while updating the software.

XI. TECHNICAL DATA

Specification	Value
Supply voltage	5V DC
Operation temperature	5-50°C
Maximum power consumption	2W
Potential-free cont. nom. out. load	230V AC / 0,5A (AC1) * 24V DC / 0,5A (DC1) **
Frequency	868MHz
Transmission	IEEE 802.11 b/g/n

* AC1 load category: single-phase, resistive or slightly inductive AC load.

** DC1 load category: direct current, resistive or slightly inductive load.

XII. PROTECTIONS AND ALARMS

The device supports the following cases within a zone:

Alarm	Possible cause	How to fix it
Damaged sensor alarm (in the case of internal sensor damage)	Internal sensor in the controller has been damaged.	Call the service staff.
No communication with the sensor/wireless regulator	<ul style="list-style-type: none"> - No range - No batteries - The batteries are flat 	<ul style="list-style-type: none"> - Place the sensor/regulator in a different place - Insert batteries to the sensor/regulator <p>The alarm is deactivated automatically when the communication is established.</p>
STT-868 actuator alarms		
Actuator alarm – ERROR #0 – low battery	The actuator battery is flat.	Replace the batteries
Actuator alarm - ERROR #1 – possible damage of mechanical or electronic parts	Some parts have been damaged	Call the service staff
Actuator alarm - ERROR#2 – the maximum actuator stroke has been exceeded	<ul style="list-style-type: none"> - No piston controlling the valve - Too big stroke (movement) of the valve - The actuator has been incorrectly mounted on the radiator - Inappropriate valve on the radiator 	<ul style="list-style-type: none"> - Install a piston controlling the actuator - Check the valve stroke - Install the actuator correctly - Replace the valve on the radiator
Actuator alarm - ERROR#3 – too little piston movement	<ul style="list-style-type: none"> - The valve got stuck - Inappropriate valve on the radiator - Too little stroke (movement) of the valve 	<ul style="list-style-type: none"> - Inspect the valve operation - Replace the valve on the radiator - Check the valve stroke
Actuator alarm - ERROR #4 – no return communication (to the actuator)	<ul style="list-style-type: none"> - Out of range - No batteries 	<ul style="list-style-type: none"> - The actuator is too far from the controller - Insert batteries into the actuator <p>After the communication is re-established, the alarm is deactivated automatically.</p>
STT-869 actuators alarms		
Error #1 - Calibration error 1 – Moving the screw to the mounting position took too much time	- The limit switch sensor is damaged	<ul style="list-style-type: none"> - Calibrate actuator again by holding the communication button until the third flash of green light - Call the service staff
Error #2 - Calibration error 2 – The screw is maximally pulled out. No resistance while pulling out	<ul style="list-style-type: none"> - The actuator has not been screwed to the valve or has not been screwed completely - The valve stroke is too big or the valve dimensions are not typical - Actuator current sensor is damaged 	<ul style="list-style-type: none"> - Check if the controller has been installed properly - Replace the batteries - Calibrate actuator again by holding the communication button until the third flash of green light - Call the service staff

Error #3 - Calibration error 3 - The screw has not been pulled out enough - the screw meets resistance too early	- The valve stroke is too small or the valve dimensions are not typical - Actuator current sensor is damaged - Low battery level	- Replace the batteries - Call the service staff
Error #4 - No feedback	- The master controller is switched off - Poor range or no range in the master controller - Radio module in the actuator is damaged	- Check if the master controller is on - Reduce the distance from the master controller - Call the service staff
Error #5 - Low battery level	The battery is flat	Replace the batteries
Error #6 - Encoder is locked	The encoder is damaged	- Calibrate actuator again by holding the communication button until the third flash of green light
Error #7 - Too high voltage	- Unevenness of the screw, the thread etc. may cause excessive resistance - Too high resistance of gear or motor - Current sensor is damaged	- Call the service staff
Error #8 - Limit switch sensor error	Limit switch sensor damaged	

TECH CONTROLLERS

EU declaration of conformity

Hereby, we declare under our sole responsibility that **EU-WiFi 8s** manufactured by TECH STEROWNIKI II Sp. z o.o., headquartered in Wieprz Biała Droga 31, 34-122 Wieprz, is compliant with Directive 2014/53/EU of the European parliament and of the Council of 16 April 2014 on the harmonisation of the laws of the Member States relating to the making available on the market of radio equipment and repealing Directive 1999/5/EC (EU OJ L 153 of 22.05.2014, p.62), Directive 2009/125/EC of 21 October 2009 establishing a framework for the setting of ecodesign requirements for energy-related products (EU OJ L 2009.285.10 as amended) as well as the regulation by the MINISTRY OF ENTREPRENEURSHIP AND TECHNOLOGY of 24 June 2019 amending the regulation concerning the essential requirements as regards the restriction of the use of certain hazardous substances in electrical and electronic equipment, implementing provisions of Directive (EU) 2017/2102 of the European Parliament and of the Council of 15 November 2017 amending Directive 2011/65/EU on the restriction of the use of certain hazardous substances in electrical and electronic equipment (OJ L 305, 21.11.2017, p. 8). For compliance assessment, harmonized standards were used:

PN-EN IEC 60730-2-9 :2019-06 art. 3.1a Safety of use

PN-EN IEC 62368-1:2020-11 art. 3.1 a Safety of use

PN-EN 62479:2011 art. 3.1 a Safety of use

ETSI EN 301 489-1 V2.2.3 (2019-11) art.3.1b Electromagnetic compatibility

ETSI EN 301 489-3 V2.1.1 (2019-03) art.3.1 b Electromagnetic compatibility

ETSI EN 301 489-17 V3.2.4 (2020-09) art.3.1b Electromagnetic compatibility

ETSI EN 300 328 V2.2.2 (2019-07) art.3.2 Effective and coherent use of radio spectrum

ETSI EN 300 220-2 V3.2.1 (2018-06) art.3.2 Effective and coherent use of radio spectrum

ETSI EN 300 220-1 V3.1.1 (2017-02) art.3.2 Effective and coherent use of radio spectrum

EN IEC 63000:2018 RoHS

Wieprz, 11.08.2022

Paweł Jura

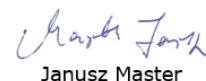
Janusz Master

Prezesa firmy

**TECH
TECH
CONTROLLERS**

Central headquarters:

ul. Biała Droga 31, 34-122 Wieprz

Service:

ul. Skotnica 120, 32-652 Bulowice

phone: **+48 33 875 93 80**

e-mail: **serwis@techsterowniki.pl**

www.tech-controllers.com