

SAMSUNG

EHS

Technical

Data Book

**EHS tank integrated Hydro Unit
for Europe
(Split, R32, 50Hz, HP)**



Model : Outdoor unit (AE***RXED*G/EU)
Hydro unit (AE***RNWS*G/EU)

History

Version	Modification	Date	Remark
Ver.1.0	Released EHS tank integrated Hydro Unit for Europe TDB (Split, R32, 50Hz, HP, 1st Version)	19. 02. 01	
Ver.1.1	Released EHS tank integrated Hydro Unit for Europe TDB (Split, R32, 50Hz, HP)	19. 05. 07	
Ver.1.2	Modified the Operation range	19. 11. 04	

Nomenclature

Outdoor Unit

Model Name



(1) Classification

AC	CAC
AM	DVM
AJ	FJM (Free Joint Multi)
AE	EHS

(2) Capacity

X1/10 kW (3 digits)

(3) Version

R	2019
---	------

(4) Product Type

S	SET (NASA)
N	Indoor Unit (NASA)
X	Outdoor Unit (NASA)
A	SET (Non NASA)
B	Indoor Unit (Non NASA)
C	Outdoor Unit (Non NASA)

(5) Feature 1

E	Split
T	TDM
Y	MONO

(6) Feature 2

D	Deluxe
P	Premium

(7) Rating Voltage

A	115V, 60hz, 1Φ
B	220V, 60Hz, 1Φ
C	208~230V, 60Hz, 1Φ
D	200~220V, 50Hz, 1Φ
E	220~240V, 50Hz, 1Φ
F	208~230V, 60Hz, 3Φ
G	380~415V, 50Hz, 3Φ

(8) Mode

G	Heat Pump (R32)
---	-----------------

Nomenclature

Tank integrated hydro unit

Model Name

AE	200	R	N	W	S	E	G	/	EU
(1)	(2)	(3)	(4)	(5)	(6)	(7)	(8)		Buyer

(1) Classification

AC	CAC
AM	DVM
AJ	FJM (Free Joint Multi)
AE	EHS

(2) Capacity

	x Liter (3 digits)
--	--------------------

(3) Version

R	2019
---	------

(4) Product Type

S	SET (NASA)
N	Indoor Unit (NASA)
X	Outdoor Unit (NASA)
A	SET (Non NASA)
B	Indoor Unit (Non NASA)
C	Outdoor Unit (Non NASA)

(5) Product Notation

W	Tank integrated hydro unit
---	----------------------------

(6) Feature

S	Split
M	Mono

(7) Rating Voltage

A	115V, 60hz, 1Φ
B	220V, 60Hz, 1Φ
C	208~230V, 60Hz, 1Φ
D	200~220V, 50Hz, 1Φ
E	220~240V, 50Hz, 1Φ
F	208~230V, 60Hz, 3Φ
G	380~415V, 50Hz, 3Φ

(8) Mode

G	Heat Pump (R32)
---	-----------------

Features & Benefits

Overview

World-class SCOP
The Highest Grade A+++

R410A R32 (All model)

Powerful Heating
90% at the Low Ambient

※ 90% of heating performance at -10°C of ambient Temp.

Low Noise Level
Min. 35dB(Sound pressure) for Split 6kW & 9kW Model

4-step Quiet Mode at Night



Tank integrated Hydro Unit

High Temp Water Outlet

Up to 65°C

※ at winter season

Wide Range of Operation

Down to -25°C

※ At winter season

Smart Wi-Fi
Control Anywhere, Anytime

※ Optional Kit

R32 Line Up
The R32 4kW~9kW Split
5kW ~ 16kW Mono

World-class Seasonal Coefficient of Performance

- Acquired A+++ Energy grade (All R32 models)

R410A R32

(All Split & Mono, A7W35 condition)

Minimum Energy Performance Standard (EU)

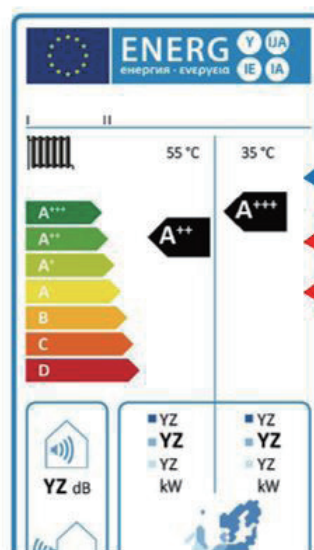

✓ It will be changed A++ to A+++.

SCOP A+++
 After 26th, Sep 2019Y

SCOP A+
 (from Sept 2017, MEPS)

SCOP A
 (from Sept 2015, MEPS)

※ according to EN14815

Features & Benefits

Higher Heating Capacity at Low Temperature

- The new models provide comfort with 90% of heating performance at -10°C of ambient temperature.

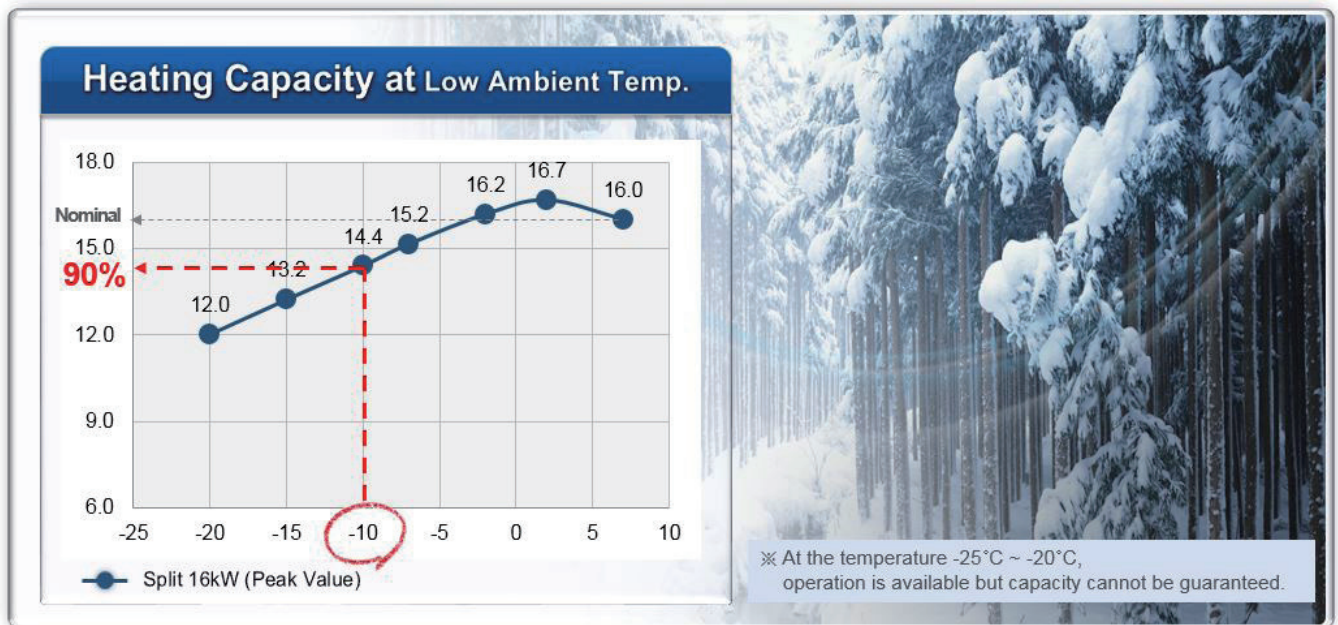

4-Step Quiet mode

- Ensure quiet operation during night time with reduced noise level at 3 ~ 7dB.
- 1 Step: ▼3dB / 2 Step: ▼5dB / 3 Step: ▼7dB / 4 Step (Default) : 35dB(A) ↓

* 4Step

- It is operated below 35dB(A) at 7°C (Ambient), 3 m away from front side of outdoor unit.



* How to enter

- 1 Enter quiet mode automatically by wired remote controller
- 2 Enter quiet mode By signal of external contact
- 3 Enter quiet mode manually by wired remote controller

※ Priority : 1 > 2 > 3

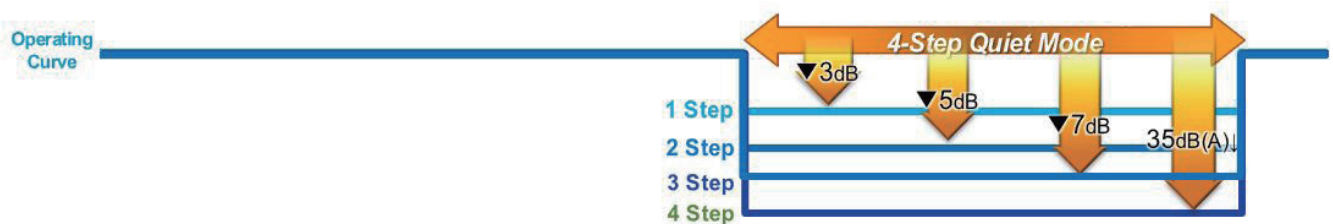

Sound pressure level is obtained in an anechoic room. It may differ depending on operation condition and acoustic environment.

Features & Benefits

Control AC Anywhere, Anytime (Optional)

- Can control your air conditioner with your smart phone.
- Can easily turn it on/off outside the house.



2-wire line for new graphic type wired remote controller

- More simple & convenient
- Communication response time : Max. 24sec → Max. 1sec

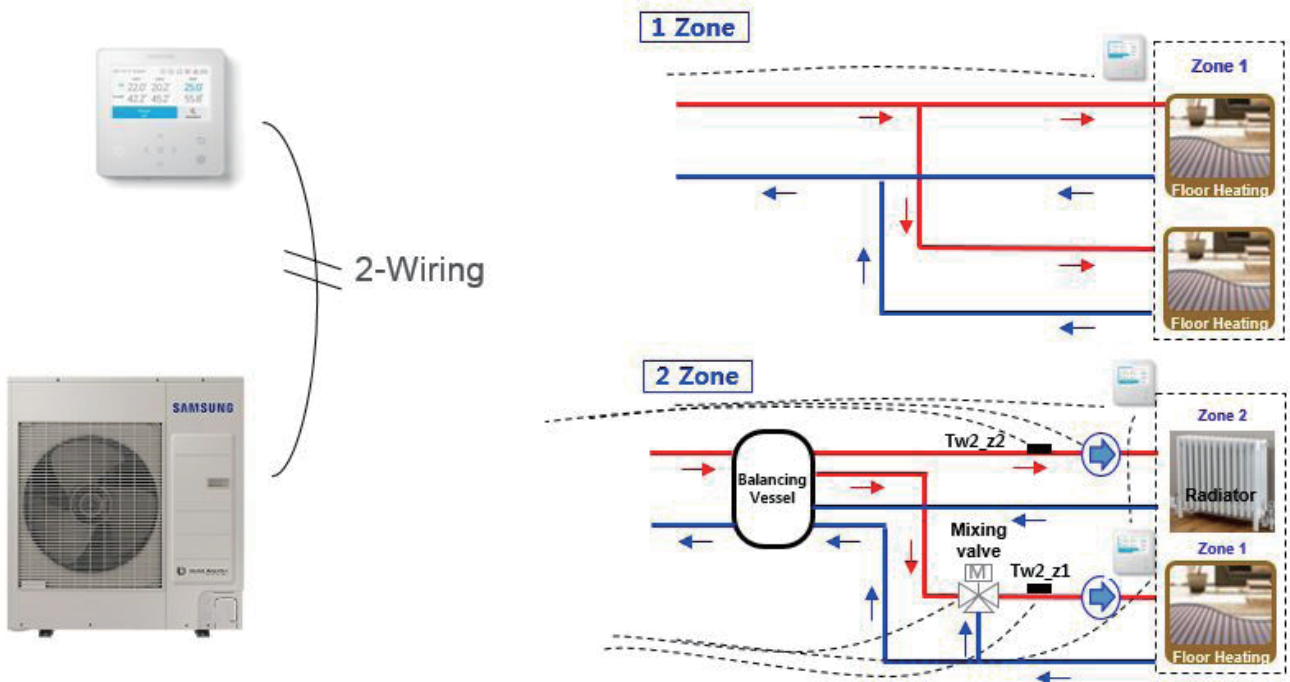



Contents

1. Line-up	9
1-1. Outdoor Units	9
1-2. Tank integrated hydro unit	9
2. Outdoor Units	10
2-1. Specifications	10
2-2. Electrical characteristics	14
2-3. Dimensional drawing	15
2-4. Electrical wiring diagram	17
2-5. Sound data	20
2-6. Operation range	23
2-7. Piping diagram	24
2-8. Capacity table	25
2-9. Capacity correction	28
3. Tank integrated hydro unit	29
3-1. Specifications	29
3-2. Dimensional drawing	33
3-3. Electrical wiring diagram	34
3-4. Sound data	36
3-5. Piping diagram	41
4. Installation	42
Tank integrated hydro unit	42
Outdoor Unit	49

1. Line-up

1-1. Outdoor Units

Capacity		4.4 / 6.6 kW	9.0 kW
Image			
Model	1phase	AE040RXEDEG/EU AE060RXEDEG/EU	AE090RXEDEG/EU
	3phase	-	AE090RXEDGG/EU

1-2. Tank integrated hydro unit

Type \ Capacity	200L	260L
Model	AE200RNWSEG/EU	AE260RNWSEG/EU AE260RNWSSG/EU
Hydro Unit		

2. Outdoor Units

2-1. Specifications

Model Name		Indoor Unit			AE200RNWSEG/EU	AE200RNWSEG/EU	AE200RNWSEG/EU		
		Outdoor Unit			AE040RXEDEG/EU	AE060RXEDEG/EU	AE090RXEDEG/EU		
Power Supply				Φ, #, V, Hz	1,2,220-240,50	1,2,220-240,50	1,2,220-240,50		
System	Mode			-	Heat Pump (A2W)	Heat Pump (A2W)	Heat Pump (A2W)		
	Performance	Capacity	Cooling	A2W Condition #1. (A7/W35) ^{1)*}	W	5,000	6,500	8,700	
					Btu/h	17,100	22,200	29,700	
			Heating	A2W Condition #1. (A7/W35) ^{1)*}	W	4,400	6,000	9,000	
					Btu/h	15,000	20,500	30,700	
				A2W condition #2	W	4,200	5,600	8,600	
				A2W condition #3		3,900	5,200	8,000	
				A2/W35 ^{4)*}		4,200	5,200	7,700	
	A-7/W35 ^{4)*}	4,600	5,500	7,900					
	Power	Power Input	Cooling	A2W Condition #1. (A7/W35) ^{1)*}	W	1,090	1,470	2,110	
						846	1,220	1,870	
			Heating	A2W condition #2		1,090	1,510	2,330	
				A2W condition #3		1,320	1,810	2,730	
				A2/W35 ^{4)*}		1,100	1,480	2,260	
				A-7/W35 ^{4)*}		1,550	2,000	2,900	
				Current Input		Cooling	A2W Condition #1. (A7/W35) ^{1)*}	A	4.90
		Heating	A2W Condition #1. (A7/W35) ^{1)*}		A	3.90	5.60	8.60	
		Current	MCA		A	16.0	16.0	22.0	
			MFA		A	20.0	20.0	27.5	
		Efficiency	EER (Nominal Cooling) A2W condition #1				4.59	4.42	4.12
			COP (Nominal Heating) A2W condition #1				5.20	4.92	4.81
			COP		A2W condition #2	W/W	3.85	3.71	3.69
							A2W condition #3	2.95	2.87
	A2/W35 ^{4)*}						3.82	3.51	3.41
	A-7/W35 ^{4)*}						2.97	2.75	2.72
	PdesignH (LWT 35°C)				5,000	6,000	8,500		
	SCOP (35°C)				4.58	4.58	4.45		
SCOP Class (35°C)				A++	A++	A++			
SEER				4.40	4.73	5.09			
Refrigerant	Piping Connections	Liquid Pipe	Φ, mm	6.35	6.35	6.35			
			Φ, inch	1/4	1/4	1/4			
		Gas Pipe	Φ, mm	15.88	15.88	15.88			
			Φ, inch	5/8	5/8	5/8			
	Piping length (ODU-IDU)	Max.[Equiv.]	m	30	30	35			
	Level difference (IDU-IDU)	Max.	m	20	20	20			
	Chargeless Length			m	15	15	15		
	Type			-	R32	R32	R32		
	Factory Charging			kg	1.2	1.2	1.4		
				tCO ₂ e	0.81	0.81	0.95		
Control Method			-	EEV	EEV	EEV			

2. Outdoor Units

2-1. Specifications

Model Name		Indoor Unit		AE200RNWSEG/EU	AE200RNWSEG/EU	AE200RNWSEG/EU	
		Outdoor Unit		AE040RXEDEG/EU	AE060RXEDEG/EU	AE090RXEDEG/EU	
Outdoor Unit	Compressor	Type		-	BLDC Twin Rotary	BLDC Twin Rotary	BLDC Twin Rotary
		Model Name		-	UB4TN8200FE4SS	UB4TN8200FE4SS	UB8TN8265FJWSG
		Oil	Type	-	POE	POE	POE
	Fan	Type		-	Propeller Fan	Propeller Fan	Propeller Fan
		Discharge direction			Horizontal	Horizontal	Horizontal
		Air Flow Rate		m ³ /min	40	43	66
		Quantity		EA	1	1	1
	Sound	Sound Pressure	Heating	dB(A)	44	47	49
			Cooling	dB(A)	46	47	49
			Night Mode	dB(A)	-	35	35
		Sound Power	Heating	dB(A)	58	60	64
			Cooling	dB(A)	61	62	63
	External Dimension	Net Weight		kg	46.5	46.5	73.0
		Shipping Weight		kg	49.5	49.5	81.5
		Net Dimensions (WxHxD)		mm	880 x 638 x 310	880 x 638 x 310	940 x 998 x 330
		Shipping Dimensions (WxHxD)		mm	1,023 x 725 x 413	1,023 x 725 x 413	995 x 1,178 x 426
	Operating Temp. Range	Heating		°C	-25~35	-25~35	-25~35
		Cooling		°C	10~46	10~46	10~46
		D.Hot Water		°C	-25~43	-25~43	-25~43

NOTE

- Specifications may be subject to change without prior notice.
 - 1)* A2W Condition #1 : (Heating) Water In/Out 30°C/35°C, Outdoor Air 7°C[DB]/6°C[WB]; (Cooling) Water In/Out 23°C/18°C, Outdoor Air 35°C[DB].
 - 2)* A2W Condition #2 : (Heating) Water In/Out 40°C/45°C, Outdoor Air 7°C[DB]/6°C[WB]; (Cooling) Water In/Out 12°C/7°C, Outdoor Air 35°C[DB].
 - 3)* A2W Condition #3 : (Heating) Water In/Out 47°C/55°C, Outdoor Air 7°C[DB]/6°C[WB].
 - 4)* A2W Condition : (A2W35) Water In/Out -/35°C, Outdoor Air 2°C[DB]/1°C[WB]; (A-7/W35) Water In/Out -/35°C, Outdoor Air -7°C[DB]/-(※ Peak Capacity)
- Select wire size based on the value of MCA
- Sound pressure level is obtained in an anechoic room.
 - Sound pressure level is a relative value, depending on the distance and acoustic environment.
 - Sound pressure level may differ depending on operation condition.
 - Sound pressure level in Night Mode is measured 3m away from front side of outdoor unit.
 - dBA = A-weighted sound pressure level
 - Reference acoustic pressure 0 dB = 20uPa
- Sound power level is an absolute value that a sound source generates.
 - dBA = A-weighted Sound power level
 - Reference power : 1pW
 - Measured according to ISO 3741
- These products contain R32 (GWP=675) which is fluorinated greenhouse gas.
- The system is operated in (-25°C ≤ Outdoor temp. < -20°C) condition, but no guarantee of capacity.
- The system is operated by only Booster Heater in special condition (35 °C < Outdoor temp. ≤ 43°C).

2. Outdoor Units

2-1. Specifications

Model Name		Indoor Unit			AE260RNWSGG/EU	AE260RNWSEG	AE260RNWSEG	AE260RNWSEG			
		Outdoor Unit			AE090RXEDGG/EU	AE040RXEDEG	AE060RXEDEG	AE090RXEDEG			
Power Supply					Φ, #, V, Hz	3,4,380-415,50	1,2,220-240,50	1,2,220-240,50	1,2,220-240,50		
System	Mode				-	Heat Pump (A2W)	Heat Pump (A2W)	Heat Pump (A2W)	Heat Pump (A2W)		
	Performance	Capacity	Cooling	A2W Condition #1. (A7/W35) ^{1)*}	W	8,700	5,000	6,500	8,700		
					Btu/h	29,700	17,100	22,200	29,700		
			Heating	A2W Condition #1. (A7/W35) ^{1)*}	W	9,000	4,400	6,000	9,000		
					Btu/h	30,700	15,000	20,500	30,700		
				A2W condition #2	W	8,600	4,200	5,600	8,600		
						8,000	3,900	5,200	8,000		
		7,700				4,200	5,200	7,700			
		7,900				4,600	5,500	7,900			
		Power	Power Input	Cooling	A2W Condition #1. (A7/W35) ^{1)*}	W	2,110	1,090	1,470	2,110	
							1,870	846	1,220	1,870	
				Heating	A2W condition #2		2,330	1,090	1,510	2,330	
							2,730	1,320	1,810	2,730	
	A2/W35 ^{4)*}				2,260		1,100	1,480	2,260		
					2,900		1,550	2,000	2,900		
	A-7/W35 ^{4)*}				3.40		4.90	6.70	9.70		
					3.00		3.90	5.60	8.60		
	Current Input			Cooling	A2W Condition #1. (A7/W35) ^{1)*}		A	3.40	4.90	6.70	9.70
				Heating	A2W Condition #1. (A7/W35) ^{1)*}		A	3.00	3.90	5.60	8.60
	Current			MCA			A	10.0	16.0	16.0	22.0
				MFA			A	16.1	20.0	20.0	27.5
	Efficiency		EER (Nominal Cooling) A2W condition #1				4.12	4.59	4.42	4.12	
			COP (Nominal Heating) A2W condition #1				4.81	5.20	4.92	4.81	
			COP		A2W condition #2	W/W	3.69	3.85	3.71	3.69	
							2.93	2.95	2.87	2.93	
							3.41	3.82	3.51	3.41	
							2.72	2.97	2.75	2.72	
		PdesignH (LWT 35°C)				8,500	5,000	6,000	8,500		
		SCOP (35°C)				4.45	4.58	4.58	4.45		
		SCOP Class (35°C)				A++	A++	A++	A++		
SEER				5.09	4.40	4.73	5.09				
Refrigerant	Piping Connections	Liquid Pipe	Φ, mm	6.35	6.35	6.35	6.35				
			Φ, inch	1/4	1/4	1/4	1/4				
		Gas Pipe	Φ, mm	15.88	15.88	15.88	15.88				
			Φ, inch	5/8	5/8	5/8	5/8				
	Piping length (ODU-IDU)	Max.[Equiv.]	m	35	30	30	35				
	Level difference (IDU-IDU)	Max.	m	20	20	20	20				
	Chargeless Length				m	15	15	15	15		
	Type				-	R32	R32	R32	R32		
	Factory Charging				kg	1.4	1.2	1.2	1.4		
					tCO ₂ e	0.95	0.81	0.81	0.95		
Control Method				-	EEV	EEV	EEV	EEV			

2. Outdoor Units

2-1. Specifications

Model Name		Indoor Unit		AE260RNWSGG/EU	AE260RNWSEG	AE260RNWSEG	AE260RNWSEG	
		Outdoor Unit		AE090RXEDGG/EU	AE040RXEDEG	AE060RXEDEG	AE090RXEDEG	
Outdoor Unit	Compressor	Type		-	BLDC Twin Rotary	BLDC Twin Rotary	BLDC Twin Rotary	BLDC Twin Rotary
		Model Name		-	UB8TN8265FJWSG	UB4TN8200FE4SS	UB4TN8200FE4SS	UB8TN8265FJWSG
		Oil	Type	-	POE	POE	POE	POE
	Fan	Type		-	Propeller Fan	Propeller Fan	Propeller Fan	Propeller Fan
		Discharge direction			Horizontal	Horizontal	Horizontal	Horizontal
		Air Flow Rate		m ³ /min	66	40	43	66
		Quantity		EA	1	1	1	1
	Sound	Sound Pressure	Heating	dB(A)	49	44	47	49
			Cooling	dB(A)	49	46	47	49
			Night Mode	dB(A)	35	-	35	35
		Sound Power	Heating	dB(A)	64	58	60	64
			Cooling	dB(A)	63	61	62	63
	External Dimension	Net Weight		kg	72.0	46.5	46.5	73.0
		Shipping Weight		kg	80.5	49.5	49.5	81.5
		Net Dimensions (WxHxD)		mm	940 x 998 x 330	880 x 638 x 310	880 x 638 x 310	940 x 998 x 330
		Shipping Dimensions (WxHxD)		mm	995 x 1,178 x 426	1,023 x 725 x 413	1,023 x 725 x 413	995 x 1,178 x 426
	Operating Temp. Range	Heating		°C	-25~35	-25~35	-25~35	-25~35
		Cooling		°C	10~46	10~46	10~46	10~46
		D.Hot Water		°C	-25~43	-25~43	-25~43	-25~43

NOTE

- Specifications may be subject to change without prior notice.
 - 1)* A2W Condition #1 : (Heating) Water In/Out 30°C/35°C, Outdoor Air 7°C[DB]/6°C[WB]; (Cooling) Water In/Out 23°C/18°C, Outdoor Air 35°C[DB].
 - 2)* A2W Condition #2 : (Heating) Water In/Out 40°C/45°C, Outdoor Air 7°C[DB]/6°C[WB]; (Cooling) Water In/Out 12°C/7°C, Outdoor Air 35°C[DB].
 - 3)* A2W Condition #3 : (Heating) Water In/Out 47°C/55°C, Outdoor Air 7°C[DB]/6°C[WB].
 - 4)* A2W Condition : (A2W35) Water In/Out -/35°C, Outdoor Air 2°C[DB]/1°C[WB]; (A-7/W35) Water In/Out -/35°C, Outdoor Air -7°C[DB]/-(※ Peak Capacity)
- Select wire size based on the value of MCA
- Sound pressure level is obtained in an anechoic room.
 - Sound pressure level is a relative value, depending on the distance and acoustic environment.
 - Sound pressure level may differ depending on operation condition.
 - Sound pressure level in Night Mode is measured 3m away from front side of outdoor unit.
 - dBA = A-weighted sound pressure level
 - Reference acoustic pressure 0 dB = 20uPa
- Sound power level is an absolute value that a sound source generates.
 - dBA = A-weighted Sound power level
 - Reference power : 1pW
 - Measured according to ISO 3741
- These products contain R32 (GWP=675) which is fluorinated greenhouse gas.
- The system is operated in (-25°C ≤ Outdoor temp. < -20°C) condition, but no guarantee of capacity.
- The system is operated by only Booster Heater in special condition (35 °C < Outdoor temp. ≤ 43°C).

2. Outdoor Units

2-2. Electrical characteristics

Capacity [kW]	Model	Power Supply				Voltage Range [V]		Nominal Running Current [A]		Current [A]	
		Φ	#	Hz	Voltage	Min. (-10%)	Max. (+10%)	Cooling	Heating	MCA	MFA
4.4	AE040RXEDEG/EU	1	2	50	220~240	198	264	4.9	3.9	16.0	20.0
6.0	AE060RXEDEG/EU	1	2	50	220~240	198	264	6.7	5.6	16.0	20.0
9.0	AE090RXEDEG/EU	1	2	50	220~240	198	264	9.7	8.6	22.0	27.5
9.0	AE090RXEDGG/EU	3	4	50	380~415	342	456	3.4	3.0	10.0	16.1

NOTE

- MCA : Minimum circuit amperes
- MFA : Maximum fuse amperes
- Select wire size based on the value of MCA

2. Outdoor Units

2-3. Dimensional drawing

AE040/060RXEDEC/EU

Unit : mm

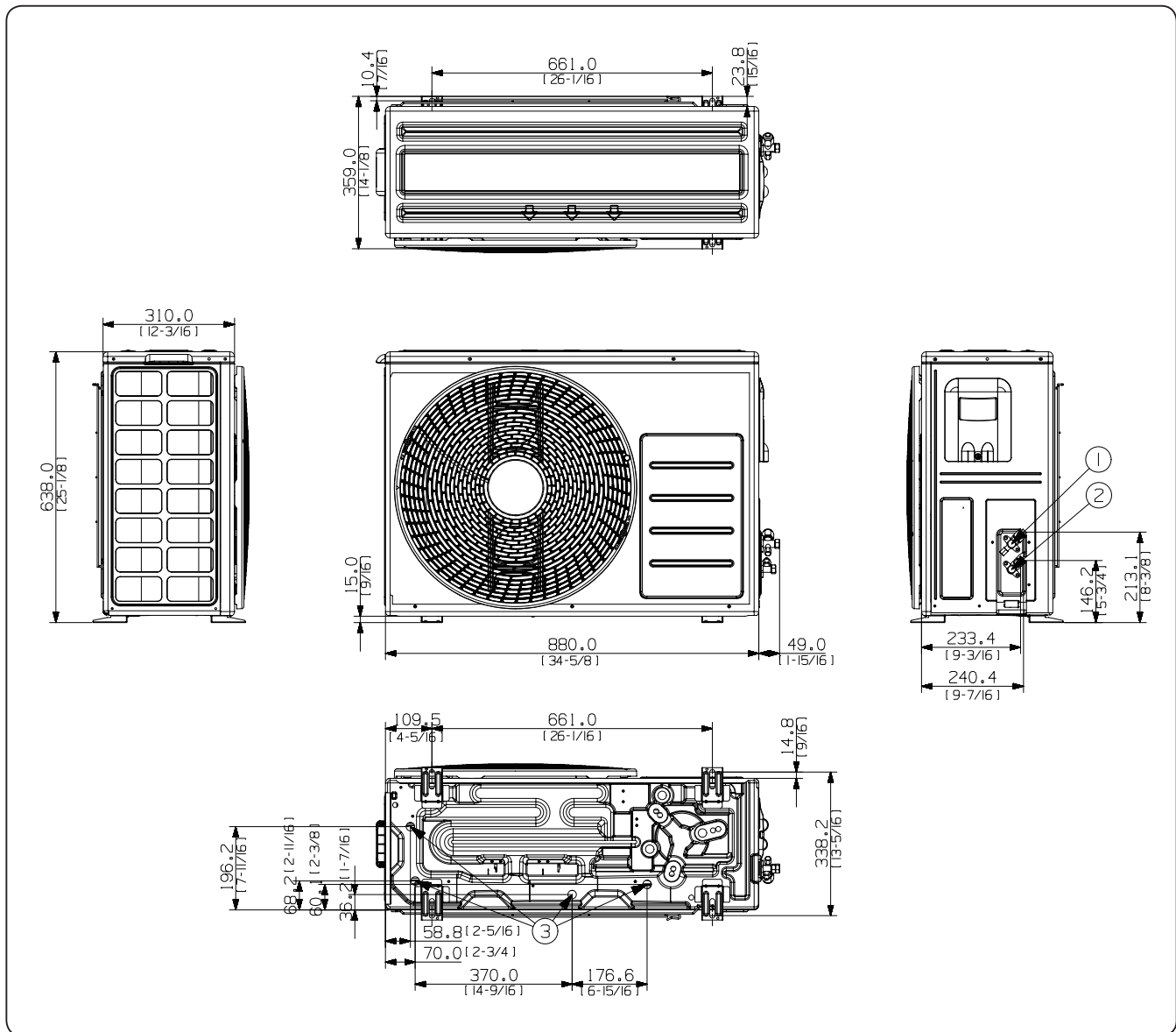

NO	Name	Description
1	Refrigerant liquid pipe	Φ6.35(1/4)
2	Refrigerant gas pipe	Φ15.88(5/8)
3	Drain holes	Connect with the provided drain plug.

2. Outdoor Units

2-5. Sound data

Summary

Capacity (kW)	Model	Sound Pressure dB(A)		Sound Power dB(A)
		Cooling	Heating	Heating
4.4	AE040RXEDEG/EU	46	44	58
6.0	AE060RXEDEG/EU	47	47	60
9.0	AE090RXEDEG/EU	49	49	64
9.0	AE090RXEDGG/EU	49	49	64

NOTE

- Specifications may be subject to change without prior notice.
- Sound Pressure Level
 - Sound pressure level is obtained in an anechoic room.
 - Sound pressure level is a relative value, depending on the distance and acoustic environment.
 - Sound pressure level may differ depending on operation condition.
 - dBA = A-weighted sound pressure level
 - Reference acoustic pressure 0 dB = 20μPa
- Sound Power Level
 - Sound power level is an absolute value that a sound source generates.
 - dBA = A-weighted sound power level.
 - Reference power : 1pW.
 - Measured according to ISO 3741.

2. Outdoor Units

2-5. Sound data

Sound Pressure level

Unit: dB(A)

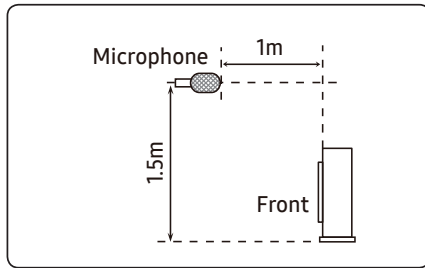

Model	Cooling	Heating
AE040RXEDEG/EU	46	44
AE060RXEDEG/EU	47	47
AE090RXEDEG/EU	49	49
AE090RXEDGG/EU	49	49

- NR Curve

1) AE040RXEDEG/EU

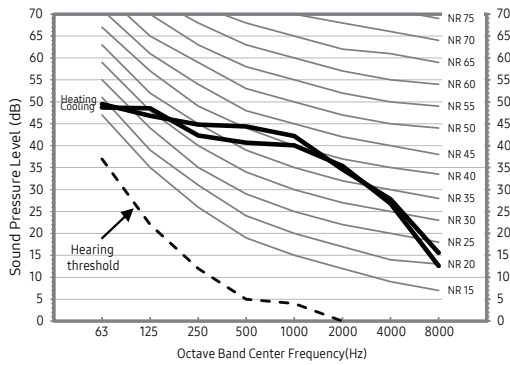

2) AE060RXEDEG/EU

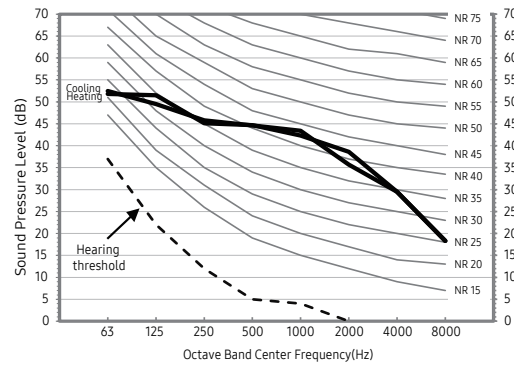

3) AE090RXEDEG/EU

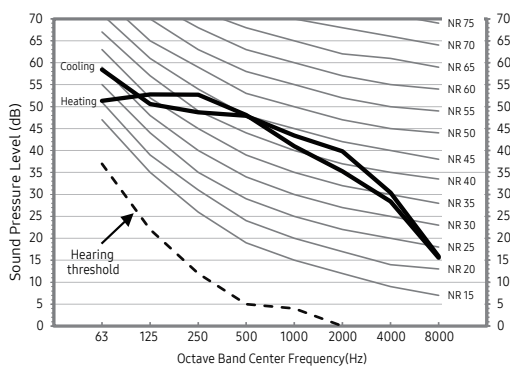

4) AE090RXEDGG/EU

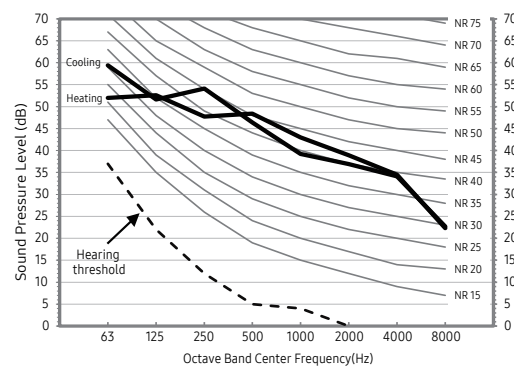

2. Outdoor Units

2-5. Sound data

Sound Power level

NOTE

- Specifications may be subject to change without prior notice
 - Sound power level is an absolute value that a sound source generates.
 - dBA = A-weighted sound power level.
 - Reference power : 1pW.
 - Measured according to ISO 3741.

Model	Power (dBA)
AE040RXEDEG/EU	58
AE060RXEDEG/EU	60
AE090RXEDEG/EU	64
AE090RXEDGG/EU	64

1) AE040RXEDEG/EU

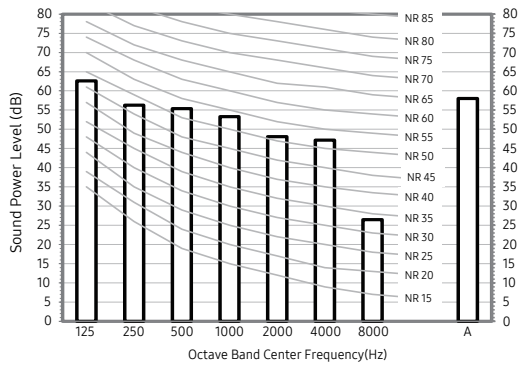

2) AE060RXEDEG/EU

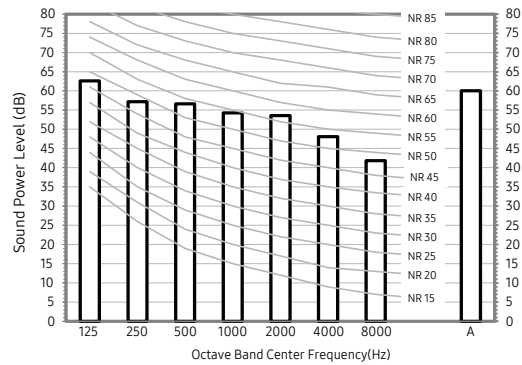

3) AE090RXEDEG/EU

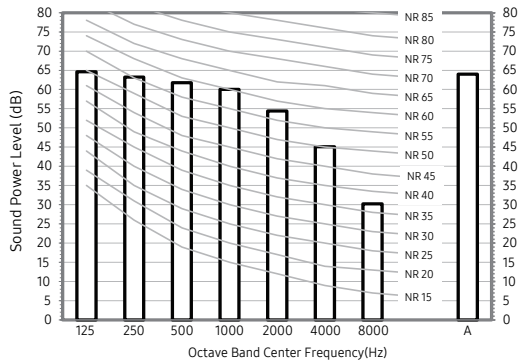

4) AE090RXEDGG/EU

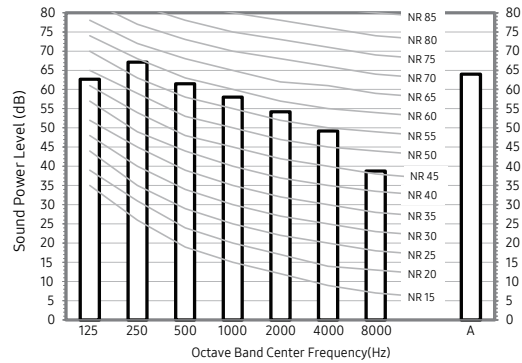

2. Outdoor Units

2-6. Operation range

1) Cooling

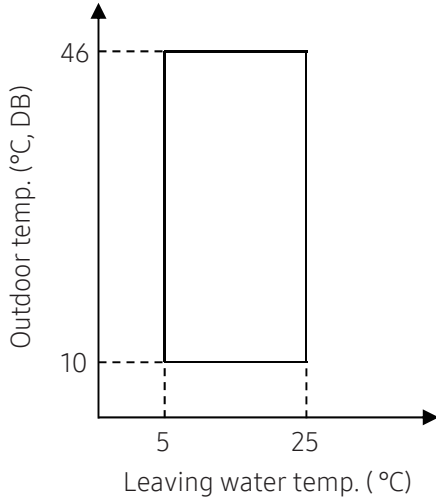

2) Heating

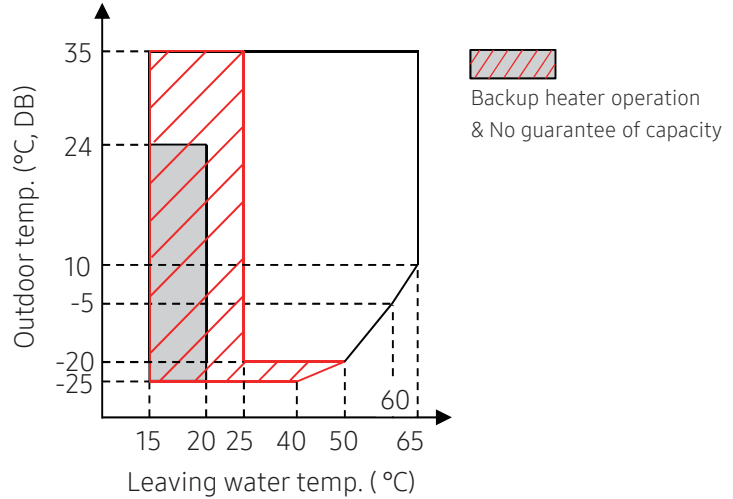

MONO Outdoor Unit		Water Temp. (°C)			Water Flow Rates (LPM)			Air Temp. (°C, DB/WB)		
		Min	Std	Max	Min	Std	Max	Min	Std	Max
Controller	Cooling	5	-	25	12 (7 ^{*1}) Δ 5°C 58 (48 ^{*1})			10/- 35/24 46/28		
	Heating	15	-	65						
Cooling	Inlet	-	23 (12 ^{*2})	30	12 (7 ^{*1}) Δ 5°C 58 (48 ^{*1})			10/- 35/24 46/28		
	Outlet	5	18 (7 ^{*2})	25						
Heating	Inlet	5	30 (40 ^{*2})	-	12 (7 ^{*1}) Δ 5°C 58 (48 ^{*1})			-25/- 7/6 35/24		
	Outlet	25 (15 ^{*3})	35 (45 ^{*2})	65						

*1) Model : AE040RXEDEG
 AE060RXEDEG
 AE090RXEDEG
 AE090RXEDGG

*2) Eurovent Test Condition #2

*3) Back up heater operation.

※ Operation of outdoor unit possible, but no guarantee of capacity in this condition.
 (-25°C ≤ Outdoor temp < -20°C)

3) DHW (Domestic Hot Water Tank)

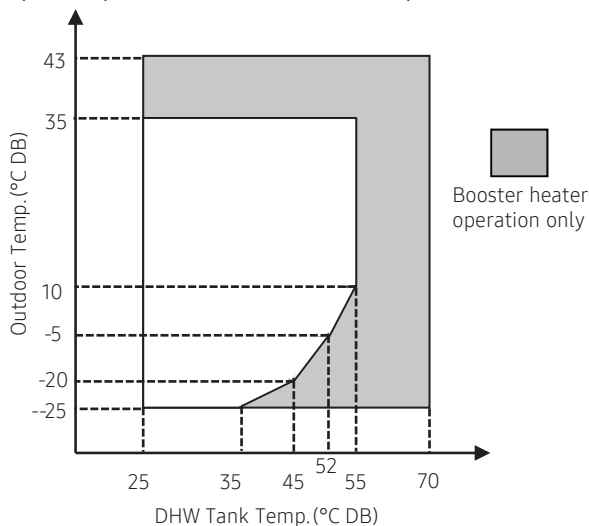

※ Special condition(35°C < Outdoor temp. ≤ 43°C) is operated by only Booster Heater.
 SAMSUNG doesn't supply DHW for EHS Split.
 Since it is a reference data, you have to check DHW operation range for yours.

2. Outdoor Units

2-7. Piping diagram

AE040/060RXEDEG/EU

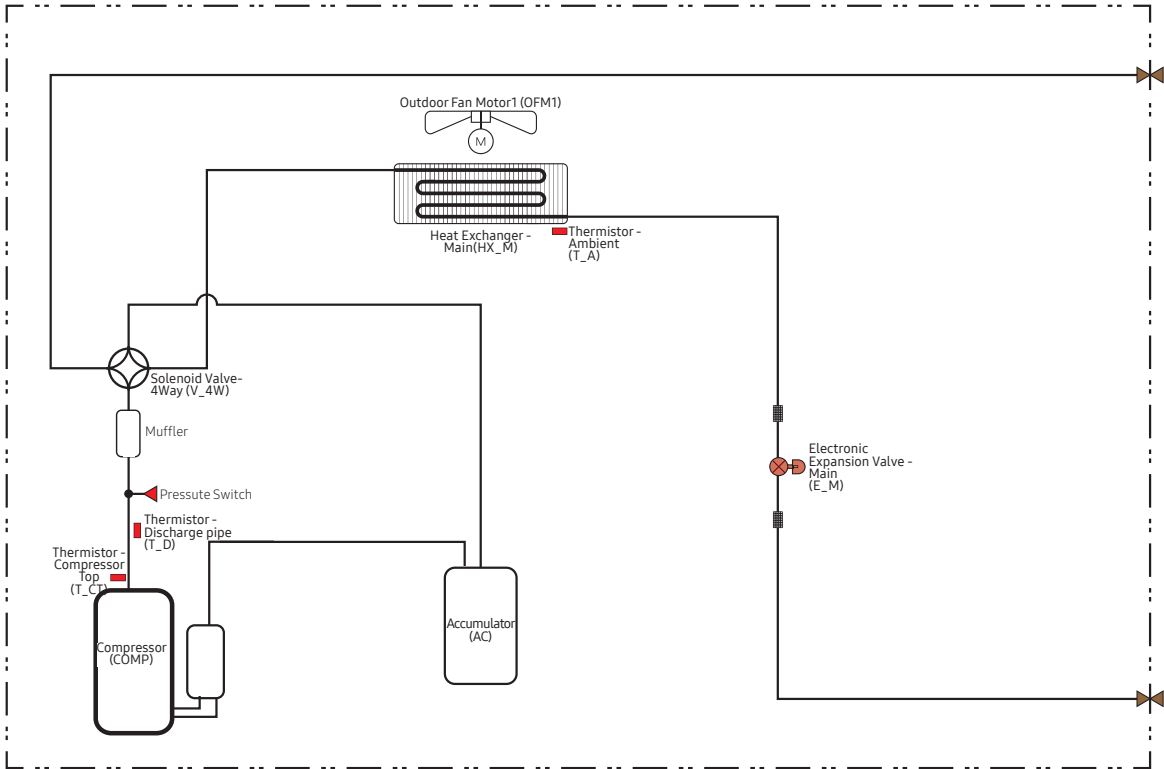

AE090RXED*G/EU

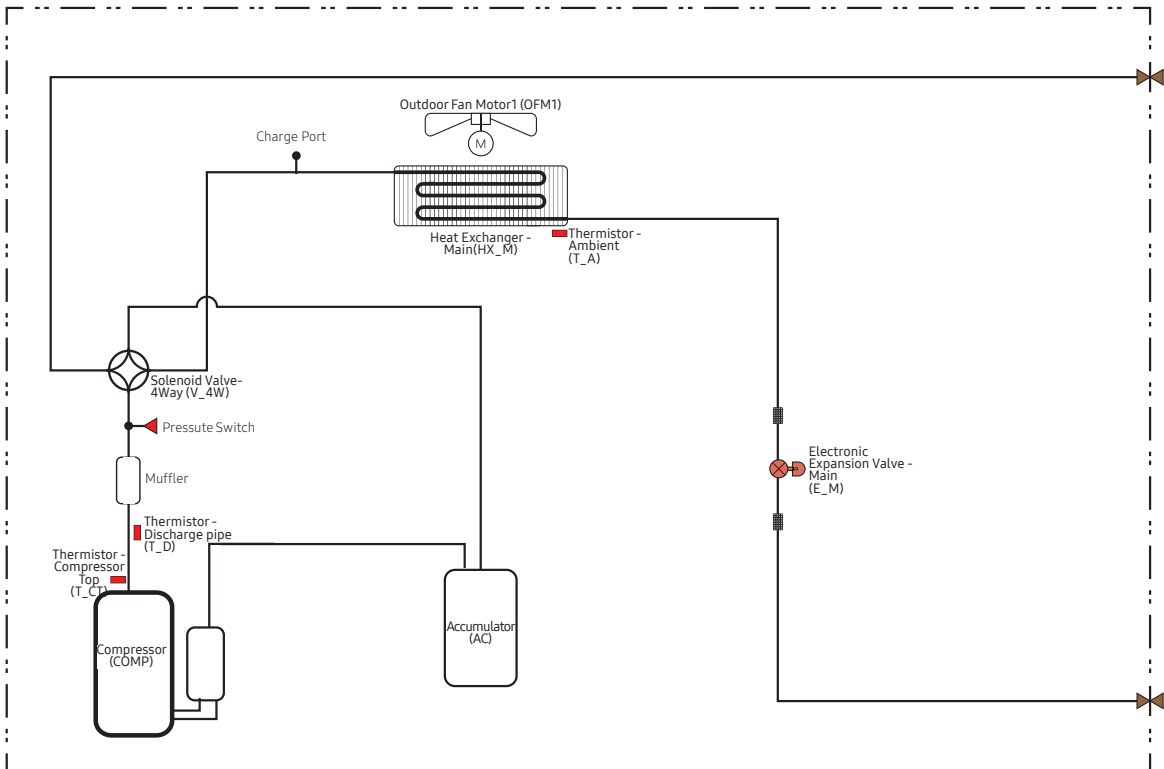

2. Outdoor Units

2-8. Capacity table

1) Maximum Heating Capacity (Peak Value)

LWT (Leaving Water Temp.), Tamb (Ambient Temp.), HC (Heating Capacity), PI (Power input)

	LWT (°C)	25		30		35		40		45		50		55		60		65		
	Tamb (°C)	HC (kW)	PI (kW)	HC (kW)	PI (kW)	HC (kW)	PI (kW)	HC (kW)	PI (kW)	HC (kW)	PI (kW)	HC (kW)	PI (kW)	HC (kW)	PI (kW)	HC (kW)	PI (kW)	HC (kW)	PI (kW)	
AE040RXEDEC	-20	3.76	1.21	3.65	1.30	3.48	1.46	3.34	1.56	3.21	1.72									
	-15	4.32	1.29	4.20	1.39	4.00	1.56	3.89	1.66	3.77	1.76	3.66	1.84							
	-10	4.97	1.34	4.83	1.44	4.60	1.62	4.46	1.73	4.32	1.84	4.19	1.93	3.89	2.12					
	-7	5.18	1.34	5.03	1.44	4.79	1.61	4.69	1.82	4.59	2.03	4.40	2.11	4.22	2.19					
	-2	5.40	1.25	5.25	1.34	5.00	1.51	4.81	1.65	4.62	1.80	4.39	1.89	4.16	1.98	3.94	2.18			
	2	5.27	1.06	5.13	1.14	4.88	1.28	4.61	1.35	4.34	1.43	4.12	1.60	3.91	1.78	3.70	1.89			
	7	4.75	0.70	4.62	0.75	4.40	0.85	4.30	0.97	4.20	1.09	4.05	1.21	3.90	1.32	3.76	1.38	3.62	1.44	
	10	5.19	0.71	5.05	0.76	4.81	0.85	4.71	0.97	4.61	1.10	4.38	1.23	4.15	1.37	3.94	1.41	3.74	1.46	
	15	5.92	0.72	5.76	0.77	5.48	0.87	5.39	0.97	5.30	1.11	5.03	1.25	4.77	1.38	4.53	1.43	4.29	1.47	
	20	6.65	0.73	6.47	0.78	6.16	0.88	6.07	0.99	5.98	1.12	5.68	1.26	5.39	1.40	5.12	1.44	4.85	1.48	
AE060RXEDEC	-20	4.69	1.63	4.56	1.75	4.35	1.97	4.18	2.10	4.01	2.32									
	-15	5.40	1.74	5.25	1.87	5.00	2.10	4.86	2.23	4.72	2.36	4.58	2.48							
	-10	5.89	1.82	5.72	1.95	5.45	2.19	5.29	2.34	5.12	2.48	4.97	2.60	4.61	2.85					
	-7	6.19	1.73	6.02	1.85	5.73	2.08	5.61	2.35	5.49	2.62	5.27	2.79	5.05	2.96					
	-2	6.57	1.64	6.38	1.76	6.08	1.98	5.85	2.17	5.62	2.37	5.34	2.66	5.06	2.96	4.79	3.29			
	2	6.53	1.43	6.35	1.53	6.05	1.72	5.71	1.82	5.37	1.92	5.11	2.16	4.84	2.40	4.58	2.55			
	7	6.48	1.01	6.30	1.09	6.00	1.22	5.70	1.37	5.40	1.51	5.10	1.66	4.80	1.81	4.53	1.88	4.27	1.95	
	10	7.08	1.02	6.88	1.10	6.55	1.23	6.30	1.38	6.04	1.53	5.74	1.73	5.43	1.92	5.16	1.98	4.89	2.04	
	15	8.08	1.04	7.85	1.11	7.48	1.25	7.29	1.39	7.10	1.57	6.74	1.77	6.39	1.97	6.07	2.03	5.75	2.09	
	20	9.07	1.05	8.82	1.13	8.40	1.27	8.28	1.42	8.16	1.61	7.75	1.81	7.34	2.01	6.98	2.08	6.61	2.14	
AE090RXED*G	-20	6.90	2.28	6.71	2.44	6.39	2.74	6.14	2.93	5.90	3.23									
	-15	7.94	2.43	7.72	2.61	7.35	2.93	7.14	3.11	6.94	3.30	6.73	3.46							
	-10	8.64	2.57	8.40	2.76	8.00	3.10	7.76	3.28	7.52	3.46	7.29	3.63	6.77	3.98					
	-7	8.89	2.51	8.64	2.69	8.23	3.02	8.05	3.41	7.88	3.80	7.56	4.04	7.25	4.29					
	-2	9.57	2.43	9.31	2.61	8.86	2.93	8.53	3.22	8.19	3.50	7.78	3.94	7.37	4.38	6.98	4.87			
	2	9.67	2.18	9.40	2.34	8.95	2.63	8.46	2.78	7.96	2.93	7.56	3.30	7.16	3.66	6.79	3.89			
	7	9.72	1.55	9.45	1.66	9.00	1.87	8.80	2.10	8.60	2.33	8.30	2.53	8.00	2.73	7.72	2.96	7.44	3.20	
	10	10.62	1.57	10.32	1.68	9.83	1.89	9.64	2.12	9.44	2.36	8.97	2.66	8.50	2.95	8.07	3.05	7.65	3.14	
	15	12.11	1.59	11.78	1.70	11.22	1.91	11.03	2.13	10.84	2.42	10.30	2.72	9.76	3.02	9.27	3.11	8.78	3.21	
	20	13.61	1.61	13.23	1.73	12.60	1.94	12.42	2.18	12.24	2.47	11.63	2.78	11.02	3.09	10.47	3.18	9.91	3.28	

1. Heating capacity : Capacity is according to Eurovent rating standard OM-3-2015 and valid for heated water range $\Delta t = 3\sim 8^{\circ}\text{C}$
 2. Cooling capacity : Capacity is according to Eurovent rating standard OM-3-2015 and valid for chilled water range $\Delta t = 3\sim 8^{\circ}\text{C}$
 3. Power input : Power input is according to Eurovent rating standard OM-3-2015.
 4. Peak value : Tested without defrost operation in accordance with EN14511
- ※ The real capacity would be changed according to the install environment.

2. Outdoor Units

2-8. Capacity table

2) Maximum Heating Capacity (Integrated Value)

LWT (Leaving Water Temp.), Tamb (Ambient Temp.), HC (Heating Capacity), PI (Power input)

	LWT (°C)	25		30		35		40		45		50		55		60		65		
	Tamb (°C)	HC (kW)	PI (kW)	HC (kW)	PI (kW)	HC (kW)	PI (kW)	HC (kW)	PI (kW)	HC (kW)	PI (kW)	HC (kW)	PI (kW)	HC (kW)	PI (kW)	HC (kW)	PI (kW)	HC (kW)	PI (kW)	
AE040RXEDEG	-20	3.76	1.21	3.65	1.30	3.48	1.46	3.34	1.56	3.21	1.72									
	-15	4.28	1.28	4.16	1.37	3.96	1.54	3.85	1.64	3.74	1.74	3.62	1.82							
	-10	4.87	1.32	4.73	1.41	4.51	1.59	4.37	1.70	4.24	1.81	4.11	1.90	3.81	2.08					
	-7	4.97	1.29	4.83	1.38	4.60	1.55	4.50	1.75	4.40	1.95	4.23	2.03	4.05	2.10					
	-2	4.75	1.10	4.62	1.18	4.40	1.33	4.23	1.46	4.07	1.59	3.87	1.67	3.66	1.75	3.47	1.92			
	2	4.54	0.91	4.41	0.98	4.20	1.10	3.97	1.16	3.73	1.23	3.55	1.38	3.36	1.53	3.18	1.70			
	7	4.75	0.70	4.62	0.75	4.40	0.85	4.30	0.97	4.20	1.09	4.05	1.21	3.90	1.32	3.76	1.38	3.62	1.44	
	10	5.19	0.71	5.05	0.76	4.81	0.85	4.71	0.97	4.61	1.10	4.38	1.23	4.15	1.37	3.94	1.41	3.74	1.46	
	15	5.92	0.72	5.76	0.77	5.48	0.87	5.39	0.97	5.30	1.11	5.03	1.25	4.77	1.38	4.53	1.43	4.29	1.47	
	20	6.65	0.73	6.47	0.78	6.16	0.88	6.07	0.99	5.98	1.12	5.68	1.26	5.39	1.40	5.12	1.44	4.85	1.48	
AE060RXEDEG	-20	4.69	1.63	4.56	1.75	4.35	1.97	4.18	2.10	4.01	2.32									
	-15	5.35	1.73	5.20	1.85	4.95	2.08	4.81	2.21	4.67	2.34	4.53	2.46							
	-10	5.77	1.78	5.61	1.91	5.34	2.15	5.18	2.29	5.02	2.43	4.87	2.55	4.52	2.80					
	-7	5.94	1.66	5.78	1.78	5.50	2.00	5.38	2.26	5.27	2.51	5.05	2.68	4.84	2.84					
	-2	5.78	1.44	5.62	1.55	5.35	1.74	5.15	1.91	4.94	2.08	4.70	2.34	4.45	2.60	4.22	2.89			
	2	5.62	1.23	5.46	1.32	5.20	1.48	4.91	1.57	4.62	1.65	4.39	1.86	4.16	2.06	3.94	2.29			
	7	6.48	1.01	6.30	1.09	6.00	1.22	5.70	1.37	5.40	1.51	5.10	1.66	4.80	1.81	4.53	1.88	4.27	1.95	
	10	7.08	1.02	6.88	1.10	6.55	1.23	6.30	1.38	6.04	1.53	5.74	1.73	5.43	1.92	5.16	1.98	4.89	2.04	
	15	8.08	1.04	7.85	1.11	7.48	1.25	7.29	1.39	7.10	1.57	6.74	1.77	6.39	1.97	6.07	2.03	5.75	2.09	
	20	9.07	1.05	8.82	1.13	8.40	1.27	8.28	1.42	8.16	1.61	7.75	1.81	7.34	2.01	6.98	2.08	6.61	2.14	
AE090RXED*G	-20	6.90	2.28	6.71	2.44	6.39	2.74	6.14	2.93	5.90	3.23									
	-15	7.86	2.41	7.64	2.58	7.28	2.90	7.07	3.08	6.87	3.26	6.66	3.43							
	-10	8.47	2.52	8.23	2.70	7.84	3.04	7.60	3.21	7.37	3.39	7.15	3.56	6.63	3.90					
	-7	8.53	2.41	8.30	2.58	7.90	2.90	7.73	3.27	7.56	3.65	7.26	3.88	6.96	4.12					
	-2	8.42	2.14	8.19	2.30	7.80	2.58	7.50	2.83	7.20	3.08	6.84	3.47	6.48	3.85	6.14	4.28			
	2	8.32	1.88	8.09	2.01	7.70	2.26	7.27	2.39	6.84	2.52	6.50	2.84	6.16	3.15	5.84	3.50			
	7	9.72	1.55	9.45	1.66	9.00	1.87	8.80	2.10	8.60	2.33	8.30	2.53	8.00	2.73	7.72	2.96	7.44	3.20	
	10	10.62	1.57	10.32	1.68	9.83	1.89	9.64	2.12	9.44	2.36	8.97	2.66	8.50	2.95	8.07	3.05	7.65	3.14	
	15	12.11	1.59	11.78	1.70	11.22	1.91	11.03	2.13	10.84	2.42	10.30	2.72	9.76	3.02	9.27	3.11	8.78	3.21	
	20	13.61	1.61	13.23	1.73	12.60	1.94	12.42	2.18	12.24	2.47	11.63	2.78	11.02	3.09	10.47	3.18	9.91	3.28	

1. Heating capacity : Capacity is according to Eurovent rating standard OM-3-2015 and valid for heated water range $\Delta t = 3\sim 8^{\circ}\text{C}$
 2. Cooling capacity : Capacity is according to Eurovent rating standard OM-3-2015 and valid for chilled water range $\Delta t = 3\sim 8^{\circ}\text{C}$
 3. Power input : Power input is according to Eurovent rating standard OM-3-2015.
 4. Integrated value : Tested with defrost operation in accordance with EN14511
- ※ The real capacity would be changed according to the install environment.

2. Outdoor Units

2-8. Capacity table

3) Cooling Capacity

LWT (Leaving Water Temp.), Tamb (Ambient Temp.), CC (Cooling Capacity), PI (Power input)

	LWT (°C)	7		10		13		15		18		25	
	Tamb (°C)	HC(kW)	PI(kW)	HC(kW)	PI(kW)	HC(kW)	PI(kW)	HC(kW)	PI(kW)	HC(kW)	PI(kW)	HC(kW)	PI(kW)
AE040RXEDEG	10	3.99	0.83	4.37	0.82	4.76	0.82	5.15	0.82	5.54	0.81	6.09	0.83
	20	3.83	0.94	4.21	0.93	4.58	0.93	4.95	0.93	5.33	0.92	5.86	0.94
	30	3.68	1.05	4.04	1.04	4.39	1.04	4.75	1.03	5.11	1.03	5.62	1.05
	35	3.60	1.11	3.95	1.11	4.30	1.10	4.65	1.10	5.00	1.09	5.50	1.11
	46	3.43	1.23	3.76	1.22	4.10	1.22	4.43	1.21	4.77	1.20	5.24	1.23
	46	3.43	1.23	3.76	1.22	4.10	1.22	4.43	1.21	4.77	1.20	5.24	1.23
AE060RXEDEG	10	5.20	1.07	5.70	1.08	6.20	1.08	6.70	1.09	7.20	1.10	7.92	1.12
	20	5.01	1.22	5.48	1.22	5.96	1.23	6.44	1.24	6.92	1.24	7.61	1.27
	30	4.80	1.36	5.26	1.37	5.72	1.37	6.18	1.38	6.64	1.39	7.31	1.42
	35	4.70	1.44	5.15	1.45	5.60	1.46	6.05	1.46	6.50	1.47	7.15	1.50
	46	4.48	1.59	4.91	1.60	5.34	1.61	5.77	1.62	6.19	1.62	6.81	1.66
	46	4.48	1.59	4.91	1.60	5.34	1.61	5.77	1.62	6.19	1.62	6.81	1.66
AE090RXED*G	10	7.20	1.45	7.80	1.48	8.41	1.51	9.02	1.54	9.63	1.57	10.59	1.60
	20	6.92	1.65	7.51	1.68	8.09	1.72	8.68	1.75	9.27	1.78	10.19	1.82
	30	6.64	1.84	7.21	1.88	7.77	1.92	8.33	1.96	8.89	1.99	9.78	2.03
	35	6.50	1.95	7.05	1.99	7.60	2.03	8.15	2.07	8.70	2.11	9.57	2.15
	46	6.19	2.15	6.72	2.20	7.24	2.24	7.77	2.29	8.29	2.33	9.12	2.38
	46	6.19	2.15	6.72	2.20	7.24	2.24	7.77	2.29	8.29	2.33	9.12	2.38

1. Heating capacity is according to Eurovent rating standard OM-3-2015 and valid for heated water range $\Delta t = 3\text{--}8^{\circ}\text{C}$
 2. Cooling capacity is according to Eurovent rating standard OM-3-2015 and valid for chilled water range $\Delta t = 3\text{--}8^{\circ}\text{C}$
 3. Power input is total of indoor and outdoor unit, according to Eurovent rating standard OM-3-2015.
- ※ The real capacity would be changed according to the install environment.

2. Outdoor Units

2-9. Capacity correction

AE040/060RXEDEG/EU

1) Heating

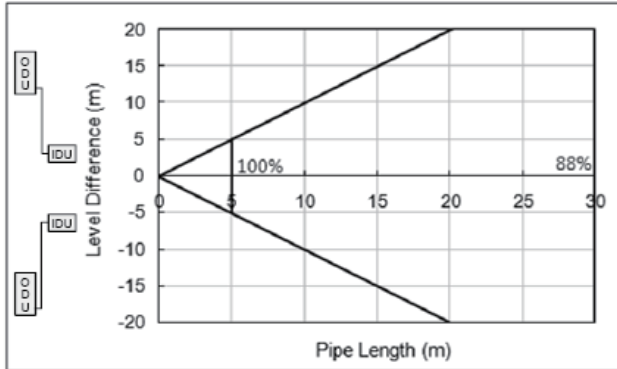

2) Cooling

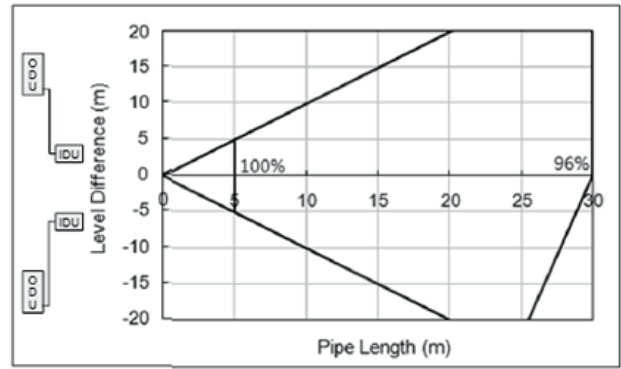

AE090RXED*G/EU

1) Heating

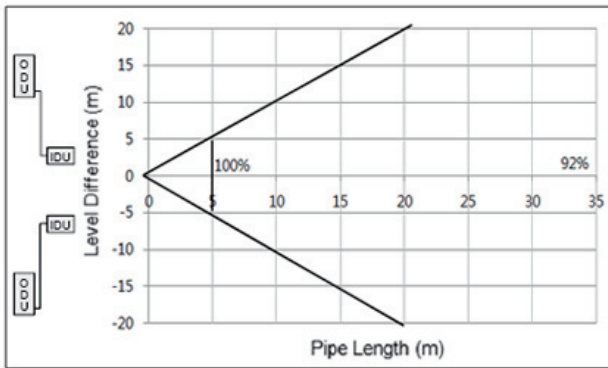

2) Cooling

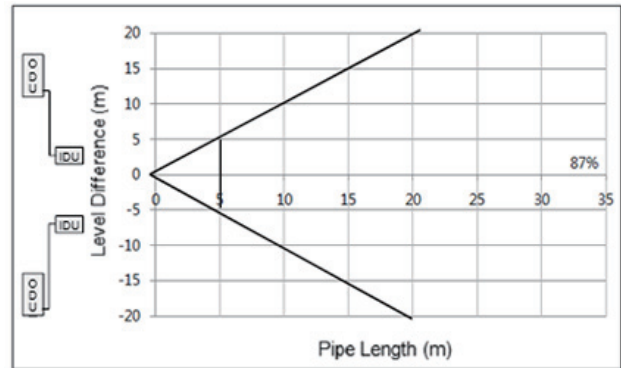

Silent mode corrections

Heating

Silent Function	Outdoor Air Temperature(°C DB)			
	-15	2	7	15
Level 1	0.92	0.87	0.94	0.94
Level 2	0.82	0.78	0.84	0.84
Level 3	0.68	0.64	0.69	0.69
Low-noise	0.7	0.6	0.69	0.69

Cooling

Silent Function	Outdoor Air Temperature(°C DB)			
	10	20	35	45
Level 1	1	1	0.92	0.92
Level 2	0.98	0.89	0.83	0.83
Level 3	0.81	0.74	0.68	0.68

3. Tank integrated hydro unit

3-1. Specifications

Model Name	Indoor Unit		AE200RNWSEG/EU	AE200RNWSEG/EU	AE200RNWSEG/EU	
	Outdoor Unit		AE040RXEDEG/EU	AE060RXEDEG/EU	AE090RXEDEG/EU	
Mode			-	Heat Pump (A2W)	Heat Pump (A2W)	Heat Pump (A2W)
Power Supply	Φ, #, V, Hz		1,2,220-240,50	1,2,220-240,50	1,2,220-240,50	
Power input	Cooling (Nominal)		kW	0.2	0.2	0.2
	Heating (Nominal)		kW	0.2	0.2	0.2
	Cooling (Max)		kW	0.2	0.2	0.2
	Heating (Max)		kW	5.2	5.2	5.2
Current Input	Cooling (Nominal)		A	0.9	0.9	0.9
	Heating (Nominal)		A	0.9	0.9	0.9
	Cooling (Max)		A	0.9	0.9	0.9
	Heating (Max)		A	22.7	22.7	22.7
Field Wiring	MCA		A	22.7	22.7	22.7
	MFA			28.4	28.4	28.4
Water Heating	Declared load profile		-	L	L	L
	Energy efficiency Class		-	A+	A+	A+
Connections	Water Flow Rate (Std)[H/C]		LPM	12.7/14.4	17.3/18.8	26.0/25.1
	Water Flow Rate	Min	LPM	7.0	7.0	7.0
		Max	LPM	48.0	48.0	48.0
	Water Pressure (Max)		bar	3	3	3
	Refrigerant pipe (To outdoor unit)	Type	-	Flare nut	Flare nut	Flare nut
		Liquid	Φ, mm	6.35	6.35	6.35
		Gas	Φ, mm	15.88	15.88	15.88
	Water pipe (Space heating)	Type	-	Straight pipe	Straight pipe	Straight pipe
		Inlet	Φ, mm	28	28	28
		Outlet	Φ, mm	28	28	28
	Water pipe (DHW)	Type	-	Straight pipe	Straight pipe	Straight pipe
		Inlet	Φ, mm	22	22	22
		Outlet	Φ, mm	22	22	22
	Water pipe (Secondary water return, Only 260L optional)	Type	-	-	-	-
Inlet		Φ, mm	-	-	-	
Leaving Water Temperature	Heating	°C	15~65	15~65	15~65	
	Cooling	°C	5~25	5~25	5~25	
DHW Tank	Nominal Water Volume		liter	200	200	200
	Net Water Volume		liter	194	194	194
	Material		-	SUS 316L	SUS 316L	SUS 316L
	Max. water pressure		bar	10	10	10
	Max. water temperature		°C	70	70	70
	Immersion heater (= booster heater)		kW	3 (230V)	3 (230V)	3 (230V)
	Insulation		-	PU Foam	PU Foam	PU Foam
Water Pump	Type		-	Centrifurugal (UPMM 25-9.5)	Centrifurugal (UPMM 25-9.5)	Centrifurugal (UPMM 25-9.5)
	Motor Input		W	100	100	100
	Number of Unit		EA	1	1	1
Backup Heater	Power		kW	2 (230V)	2 (230V)	2 (230V)
	Thermostat (Thermal Fuse)		°C	65 (93)	65 (93)	65 (93)

3. Tank integrated hydro unit

3-1. Specifications

Model Name		Indoor Unit		AE200RNWSEG/EU	AE200RNWSEG/EU	AE200RNWSEG/EU
		Outdoor Unit		AE040RXEDEG/EU	AE060RXEDEG/EU	AE090RXEDEG/EU
Safety device	Pressure relief valve		bar	2.9	2.9	2.9
	Flow Sensor		LPM	5~60	5~60	5~60
	Temperature & Pressure relief valve (Tank)		bar, °C	7, 90	7, 90	7, 90
	Thermostat(for immersion heater)		°C	49~82±5 (Auto, On : 15°C±3°C↓)	49~82±5 (Auto, On : 15°C±3°C↓)	49~82±5 (Auto, On : 15°C±3°C↓)
Expansion vessel	Internal water volume		liter	8	8	8
	Working pressure		MPa	0.3	0.3	0.3
Water Pump (Primary)	Type		-	BLDC Inv	BLDC Inv	BLDC Inv
	Max static pressure		mAq	9.5	9.5	9.5
Water Heat Exchanger	Type		-	Braszed Plate Exchager	Braszed Plate Exchager	Braszed Plate Exchager
	Internal water volume		L	1.01(Water Side) 0.98(Refrigerant Side)	1.01(Water Side) 0.98(Refrigerant Side)	1.01(Water Side) 0.98(Refrigerant Side)
IP Class			-	IPX1	IPX1	IPX1
Air Purge Valve			Φ, inch	BSPP male 3/8	BSPP male 3/8	BSPP male 3/8
Service Valve			Φ, inch	BSPP male 1 1/4	BSPP male 1 1/4	BSPP male 1 1/4
Sound	Sound Pressure	Heating	dB(A)	26	26	26
		Cooling	dB(A)	26	26	26
	Sound Power	Heating	dB(A)	40	40	40
External Dimension	Net Weight		kg	136.0	136.0	136.0
	Shipping Weight		kg	148.0	148.0	148.0
	Net Dimensions (WxHxD)		mm	595 x 1,800 x 700	595 x 1,800 x 700	595 x 1,800 x 700
	Shipping Dimensions (WxHxD)		mm	700 x 2,000 x 780	700 x 2,000 x 780	700 x 2,000 x 780

NOTE

- Specifications may be subject to change without prior notice.

3. Tank integrated hydro unit

3-1. Specifications

Model Name		Indoor Unit		AE260RNWSGG/EU	AE260RNWSEG/EU	AE260RNWSEG/EU	AE260RNWSEG/EU
		Outdoor Unit		AE090RXEDGG/EU	AE040RXEDEG/EU	AE060RXEDEG/EU	AE090RXEDEG/EU
Mode		-		Heat Pump (A2W)	Heat Pump (A2W)	Heat Pump (A2W)	Heat Pump (A2W)
Power Supply		Φ, #, V, Hz		1,2,220-240,50 3,4,380-415,50	1,2,220-240,50	1,2,220-240,50	1,2,220-240,50
Power input	Cooling (Nominal)	kW		3Φ - /1Φ 0.20	0.2	0.2	0.2
	Heating (Nominal)	kW		3Φ - /1Φ 0.20	0.2	0.2	0.2
	Cooling (Max)	kW		3Φ - /1Φ 0.20	0.2	0.2	0.2
	Heating (Max)	kW		3Φ 6.00 /1Φ 3.20	5.2	5.2	5.2
Current Input	Cooling (Nominal)	A		3Φ - /1Φ 0.9	0.9	0.9	0.9
	Heating (Nominal)	A		3Φ - /1Φ 0.9	0.9	0.9	0.9
	Cooling (Max)	A		3Φ - /1Φ 0.9	0.9	0.9	0.9
	Heating (Max)	A		3Φ 8.7 /1Φ 14.0	22.7	22.7	22.7
Field Wiring	MCA	A		1Φ 14.0 / 3Φ 8.7	22.7	22.7	22.7
	MFA			11.6	28.4	28.4	28.4
Water Heating	Declared load profile		-	XL	XL	XL	XL
	Energy efficiency Class		-	A+	A+	A+	A+
Connections	Water Flow Rate (Std)[H/C]		LPM	26.0/25.1	12.7/14.4	17.3/18.8	26.0/25.1
	Water Flow Rate	Min	LPM	7.0	7.0	7.0	7.0
		Max	LPM	48.0	48.0	48.0	48.0
	Water Pressure (Max)		bar	3	3	3	3
	Refrigerant pipe (To outdoor unit)	Type	-	Flare nut	Flare nut	Flare nut	Flare nut
		Liquid	Φ, mm	6.35	6.35	6.35	6.35
		Gas	Φ, mm	15.88	15.88	15.88	15.88
	Water pipe (Space heating)	Type	-	Straight pipe	Straight pipe	Straight pipe	Straight pipe
		Inlet	Φ, mm	28	28	28	28
		Outlet	Φ, mm	28	28	28	28
	Water pipe (DHW)	Type	-	Straight pipe	Straight pipe	Straight pipe	Straight pipe
		Inlet	Φ, mm	22	22	22	22
		Outlet	Φ, mm	22	22	22	22
	Water pipe (Secondary water return, Only 260L optional)	Type	-	Straight pipe	Straight pipe	Straight pipe	Straight pipe
		Inlet	Φ, mm	22	22	22	22
Leaving Water Temperature	Heating	°C	15~65	15~65	15~65	15~65	
	Cooling	°C	5~25	5~25	5~25	5~25	
DHW Tank	Nominal Water Volume		liter	260	260	260	260
	Net Water Volume		liter	254	254	254	254
	Material		-	SUS 316L	SUS 316L	SUS 316L	SUS 316L
	Max. water pressure		bar	10	10	10	10
	Max. water temperature		°C	70	70	70	70
	Immersion heater (= booster heater)		kW	3 (230V)	3 (230V)	3 (230V)	3 (230V)
	Insulation		-	PU Foam	PU Foam	PU Foam	PU Foam
Water Pump	Type		-	Centrifurugal (UPMM 25-9.5)	Centrifurugal (UPMM 25-9.5)	Centrifurugal (UPMM 25-9.5)	Centrifurugal (UPMM 25-9.5)
	Motor Input		W	100	100	100	100
	Number of Unit		EA	1	1	1	1
Backup Heater	Power		kW	6 (3Φ 400V)	2 (230V)	2 (230V)	2 (230V)
	Thermostat (Thermal Fuse)		°C	65 (93)	65 (93)	65 (93)	65 (93)

3. Tank integrated hydro unit

3-1. Specifications

Model Name		Indoor Unit		AE260RNWSGG/EU	AE260RNWSEG/EU	AE260RNWSEG/EU	AE260RNWSEG/EU
		Outdoor Unit		AE090RXEDGG/EU	AE040RXEDEG/EU	AE060RXEDEG/EU	AE090RXEDEG/EU
Safety device	Pressure relief valve	bar	2.9	2.9	2.9	2.9	2.9
	Flow Sensor	LPM	5~60	5~60	5~60	5~60	5~60
	Temperature & Pressure relief valve (Tank)	bar, °C	7, 90	7, 90	7, 90	7, 90	7, 90
	Thermostat(for immersion heater)	°C	49~82±5 (Auto, On : 15°C±3°C↓)	49~82±5 (Auto, On : 15°C±3°C↓)	49~82±5 (Auto, On : 15°C±3°C↓)	49~82±5 (Auto, On : 15°C±3°C↓)	49~82±5 (Auto, On : 15°C±3°C↓)
Expansion vessel	Internal water volume	liter	8	8	8	8	8
	Working pressure	MPa	0.3	0.3	0.3	0.3	0.3
Water Pump (Primary)	Type	-	BLDC Inv	BLDC Inv	BLDC Inv	BLDC Inv	BLDC Inv
	Max static pressure	mAq	9.5	9.5	9.5	9.5	9.5
Water Heat Exchanger	Type	-	Braszed Plate Exchanger	Braszed Plate Exchanger	Braszed Plate Exchanger	Braszed Plate Exchanger	Braszed Plate Exchanger
	Internal water volume	L	1.01(Water Side) 0.98(Refrigerant Side)	1.01(Water Side) 0.98(Refrigerant Side)	1.01(Water Side) 0.98(Refrigerant Side)	1.01(Water Side) 0.98(Refrigerant Side)	1.01(Water Side) 0.98(Refrigerant Side)
IP Class		-	IPX1	IPX1	IPX1	IPX1	IPX1
Air Purge Valve		Φ, inch	BSP male 3/8	BSP male 3/8	BSP male 3/8	BSP male 3/8	BSP male 3/8
Service Valve		Φ, inch	BSP male 1 1/4	BSP male 1 1/4	BSP male 1 1/4	BSP male 1 1/4	BSP male 1 1/4
Sound	Sound Pressure	Heating	dB(A)	26	26	26	26
		Cooling	dB(A)	26	26	26	26
	Sound Power	Heating	dB(A)	40	40	40	40
External Dimension	Net Weight	kg	146.0	146.0	146.0	146.0	146.0
	Shipping Weight	kg	158.0	158.0	158.0	158.0	158.0
	Net Dimensions (WxHxD)	mm	595 x 1,800 x 700	595 x 1,800 x 700	595 x 1,800 x 700	595 x 1,800 x 700	595 x 1,800 x 700
	Shipping Dimensions (WxHxD)	mm	700 x 2,000 x 780	700 x 2,000 x 780	700 x 2,000 x 780	700 x 2,000 x 780	700 x 2,000 x 780

NOTE

- Specifications may be subject to change without prior notice.

3. Tank integrated hydro unit

3-2. Dimensional drawing

AE200/260RNWS*G/EU

Unit : mm

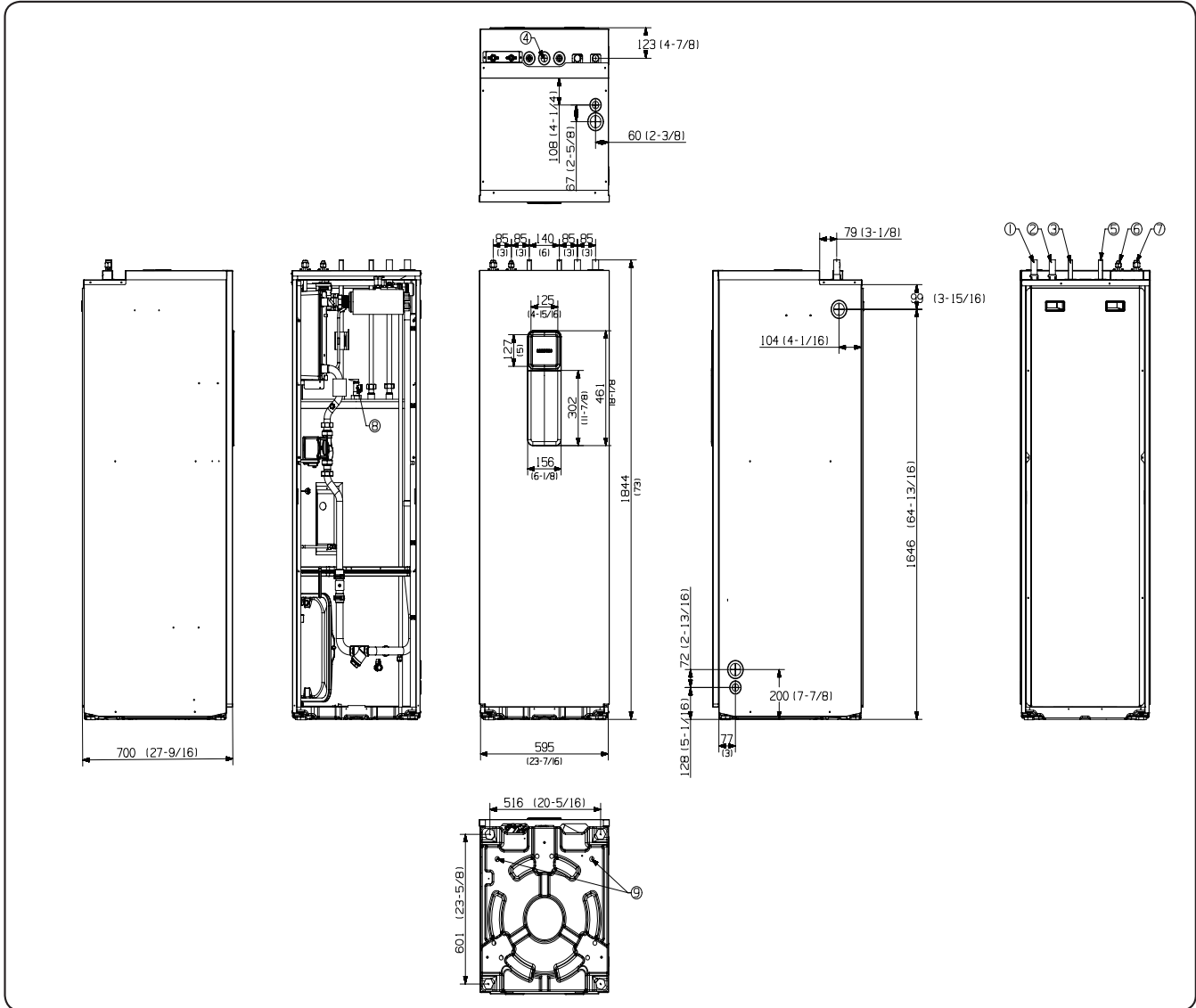

NO	Name	Description	
		AE200RNWSEG/EU	AE260RNWS*G/EU
1	Space heating Inlet	Ø28	Ø28
2	Space heating Outlet	Ø28	Ø28
3	DHW Inlet	Ø22	Ø22
4	Secondary water return	N/A	Ø22
5	DHW Outlet	Ø22	Ø22
6	Refrigerant liquid pipe	Ø9.52	Ø9.52
7	Refrigerant Gas pipe	Ø15.88	Ø15.88
8	T/P v/v	Female PT 1/2"	Female PT 1/2"
9	Drain Holes	(Option) Connect with the provided drain plug	

3. Tank integrated hydro unit

3-3. Electrical wiring diagram

AE200RNWSEG/EU, AE260RNWSEG/EU

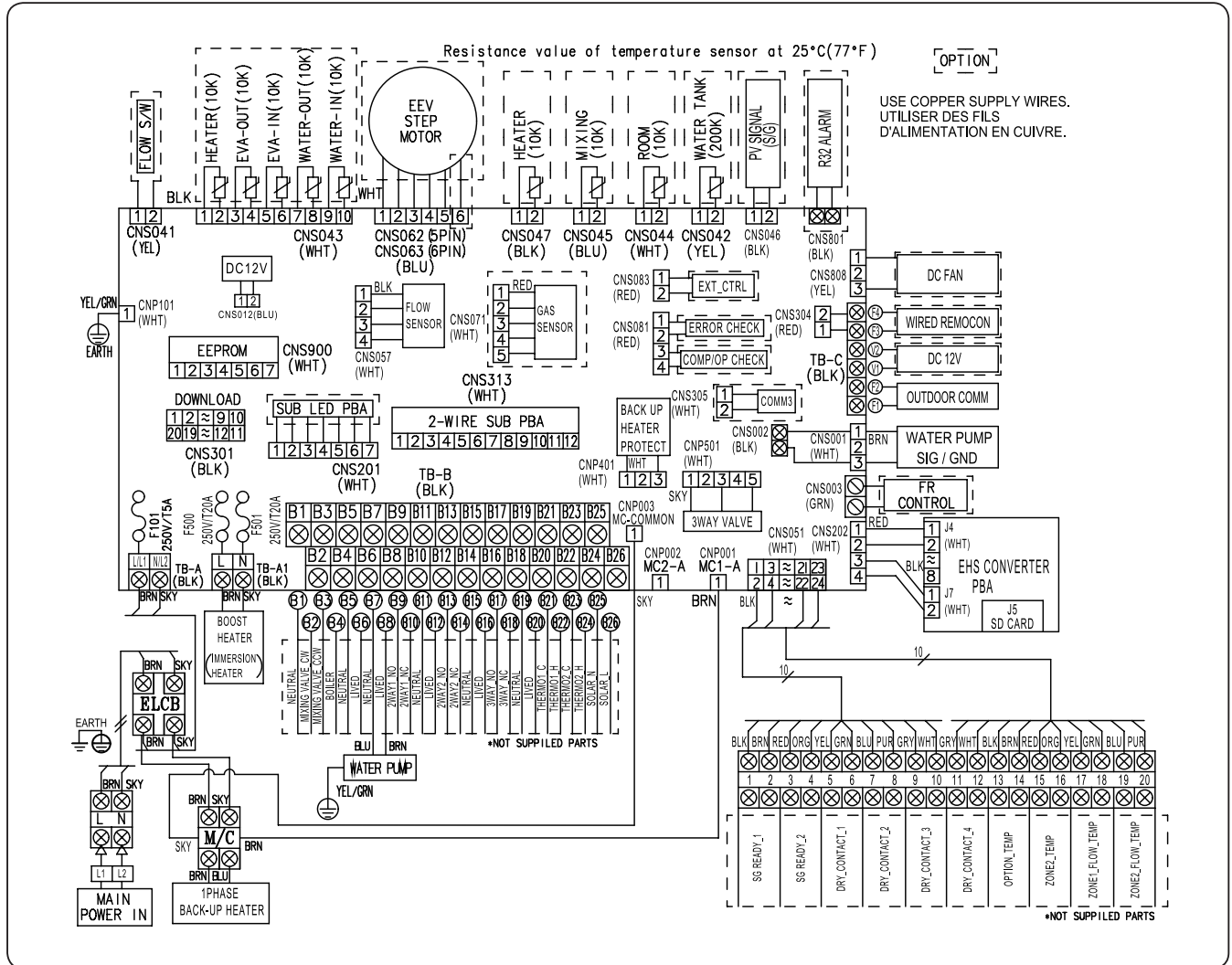

HEATER	Thermistor HEATER(10K)	EVA-OUT	Thermistor EVA-OUT(10K)
EVA-IN	Thermistor EVA-IN(10K)	WATER-OUT	Thermistor WATER-OUT(10K)
WATER-IN	Thermistor WATER-IN(10K)	WATER TANK	Thermistor WATER TANK(200K)
MIXING	Thermistor MIXING VALVE(10K)	WIRED REMOCON	Wired Remote Controller
OUTDOOR COMM	Outdoor Communication	SIG/GND	Signal/Ground
ELCB	Earth Leakage Circuit Breaker	M/C	Magnetic Contactor

NOTE

1. This wiring diagram applies only to the Indoor unit.
2. Symbols show as follow :
blk: black, red: red, blu: blue, wht: white, yel: yellow, brn: brown, sky: skyblue, grn: green
3. For connection wiring indoor-outdoor transmission F1-F2, indoor-wired remote controller transmission F3-F4.
4. Protective earth(SCREW)

3. Tank integrated hydro unit

3-4. Sound data

Summary

Capacity (Liter)	Model	Sound Pressure dB(A) (Heating)	Sound Power dB(A) (Heating)
200	AE200RNWSEG/EU+AE040RXEDEG/EU	26	40
	AE200RNWSEG/EU+AE060RXEDEG/EU	26	40
	AE200RNWSEG/EU+AE090RXEDEG/EU	26	40
260	AE260RNWSEG/EU+AE090RXEDGG/EU	26	40
260	AE260RNWSEG/EU + AE040RXEDEG/EU	26	40
	AE260RNWSEG/EU + AE060RXEDEG/EU	26	40
	AE260RNWSEG/EU + AE090RXEDEG/EU	26	40

NOTE

- Specifications may be subject to change without prior notice.
- Sound Pressure Level
 - Sound pressure level is obtained in an anechoic room.
 - Sound pressure level is a relative value, depending on the distance and acoustic environment.
 - Sound pressure level may differ depending on operation condition.
 - dBA = A-weighted sound pressure level
 - Reference acoustic pressure 0 dB = 20μPa
- Sound Power Level
 - Sound power level is an absolute value that a sound source generates.
 - dBA = A-weighted sound power level.
 - Reference power : 1pW.
 - Measured according to ISO 3741.

3. Tank integrated hydro unit

3-4. Sound data

Sound Pressure level

Unit: dB(A)

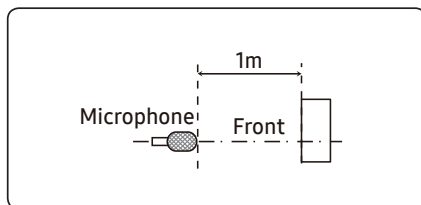

Model	Heating
AE200RNWSEG/EU+AE040RXEDEG/EU	26
AE200RNWSEG/EU+AE060RXEDEG/EU	26
AE200RNWSEG/EU+AE090RXEDEG/EU	26
AE260RNWSGG/EU+AE090RXEDGG/EU	26

- NR Curve

1) AE200RNWSEG/EU+AE040RXEDEG/EU

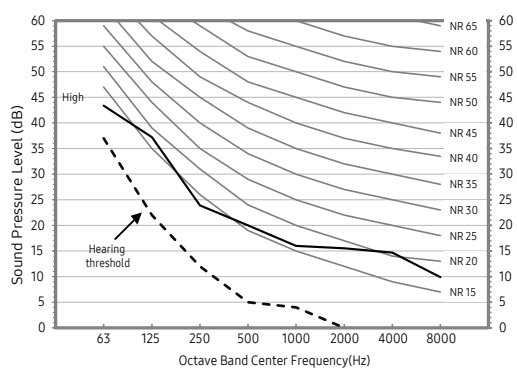

2) AE200RNWSEG/EU+AE060RXEDEG/EU

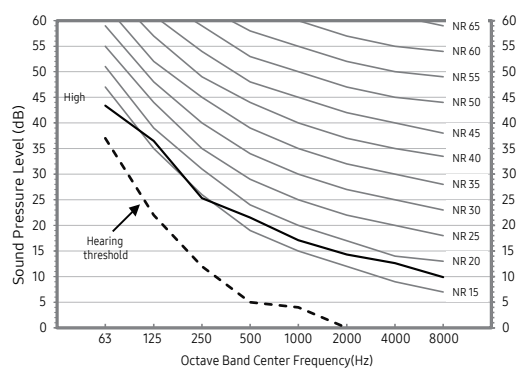

3) AE200RNWSEG/EU+AE090RXEDEG/EU

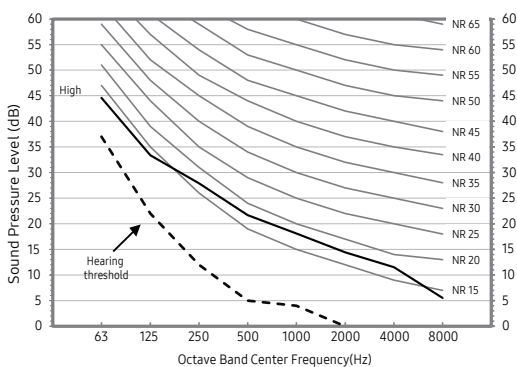

4) AE260RNWSGG/EU+AE090RXEDGG/EU

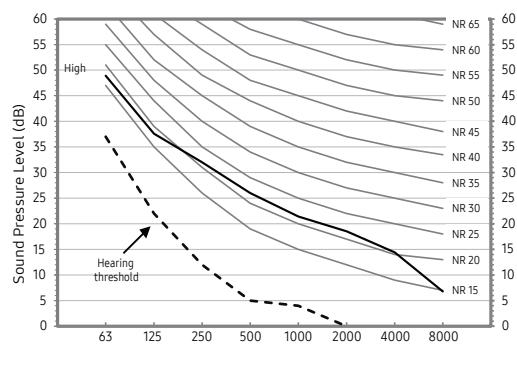

NOTE

- Specifications may be subject to change without prior notice.
- Sound Pressure Level
 - Sound pressure level is obtained in an anechoic room.
 - Sound pressure level is a relative value, depending on the distance and acoustic environment.
 - Sound pressure level may differ depending on operation condition.
 - dBA = A weighted sound pressure level
 - Reference acoustic pressure 0 dB = 20μPa

3. Tank integrated hydro unit

3-4. Sound data

Sound Pressure level

Unit: dB(A)

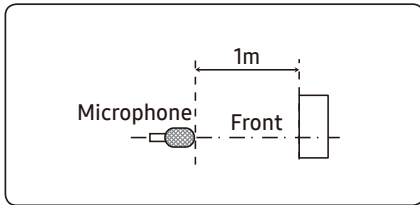

Model	Heating
AE260RNWSEG/EU + AE040RXEDEG/EU	26
AE260RNWSEG/EU + AE060RXEDEG/EU	26
AE260RNWSEG/EU + AE090RXEDEG/EU	26

- NR Curve

1) AE260RNWSEG/EU + AE040RXEDEG/EU

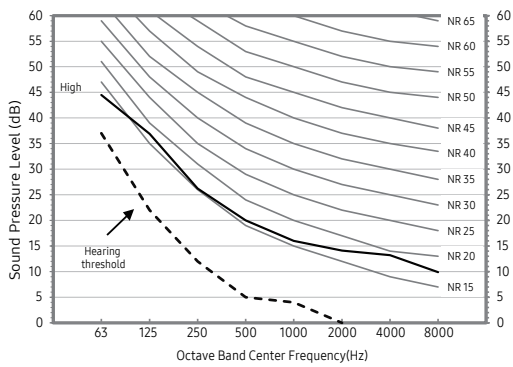

2) AE260RNWSEG/EU + AE060RXEDEG/EU

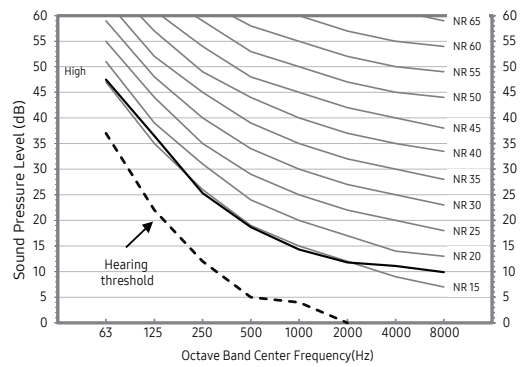

3) AE260RNWSEG/EU + AE090RXEDEG/EU

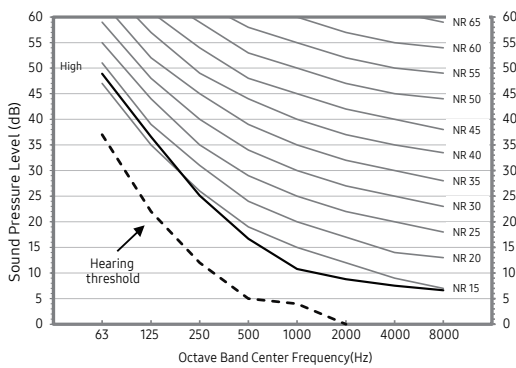

NOTE

- Specifications may be subject to change without prior notice.
- Sound Pressure Level
 - Sound pressure level is obtained in an anechoic room.
 - Sound pressure level is a relative value, depending on the distance and acoustic environment.
 - Sound pressure level may differ depending on operation condition.
 - dBA = A weighted sound pressure level
 - Reference acoustic pressure 0 dB = 20μPa

3. Tank integrated hydro unit

3-4. Sound data

Sound Power level

NOTE

- Specifications may be subject to change without prior notice
 - Sound power level is an absolute value that a sound source generates.
 - dBA = A-weighted sound power level.
 - Reference power : 1pW.
 - Measured according to ISO 3741.

Model	Power (dBA)
AE200RNWSEG/EU+AE040RXEDEG/EU	40
AE200RNWSEG/EU+AE060RXEDEG/EU	40
AE200RNWSEG/EU+AE090RXEDEG/EU	40
AE260RNWSGG/EU+AE090RXEDGG/EU	40

1) AE200RNWSEG/EU+AE040RXEDEG/EU

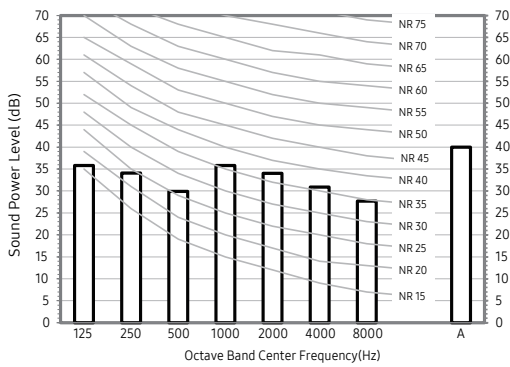

2) AE200RNWSEG/EU+AE060RXEDEG/EU

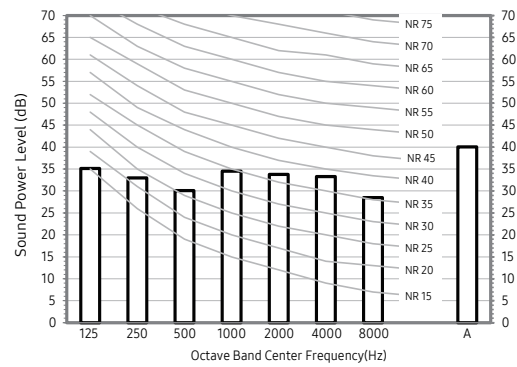

3) AE200RNWSEG/EU+AE090RXEDEG/EU

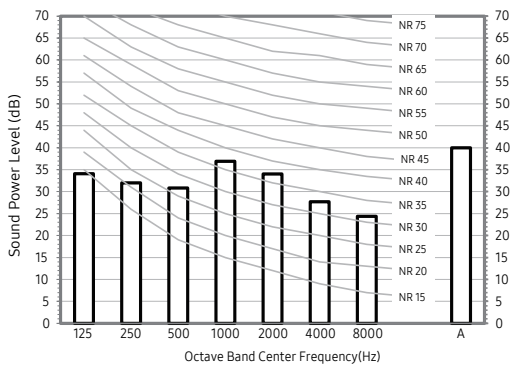

4) AE260RNWSGG/EU+AE090RXEDGG/EU

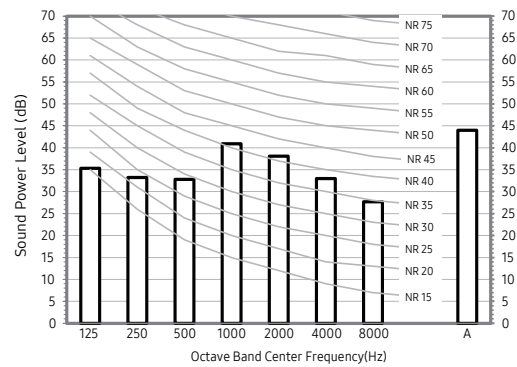

3. Tank integrated hydro unit

3-4. Sound data

Sound Power level

NOTE

- Specifications may be subject to change without prior notice
- Sound power level is an absolute value that a sound source generates.
- dBA = A-weighted sound power level.
- Reference power : 1pW.
- Measured according to ISO 3741.

Model	Power (dBA)
AE260RNWSEG/EU + AE040RXEDEG/EU	40
AE260RNWSEG/EU + AE060RXEDEG/EU	40
AE260RNWSEG/EU + AE090RXEDEG/EU	40

1) AE260RNWSEG/EU + AE040RXEDEG/EU

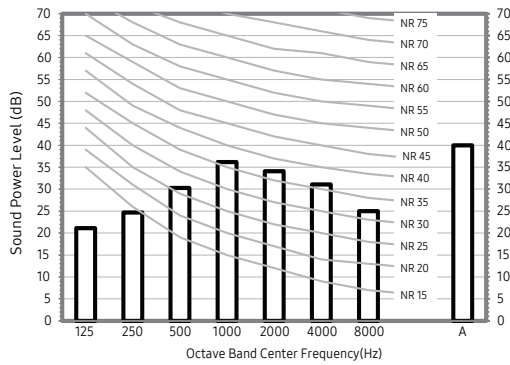

2) AE260RNWSEG/EU + AE060RXEDEG/EU

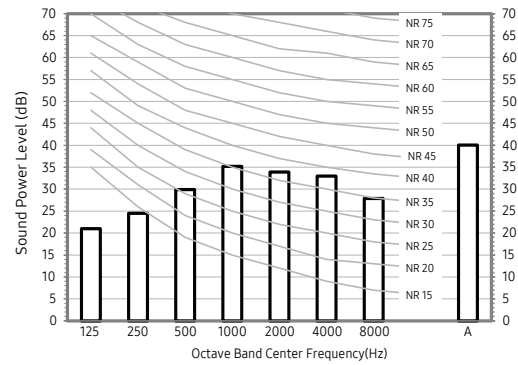

3) AE260RNWSEG/EU + AE090RXEDEG/EU

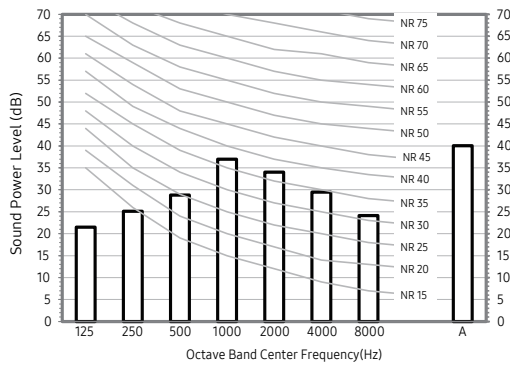

3. Tank integrated hydro unit

3-5. Piping diagram

AE200/260RNWS*G/EU

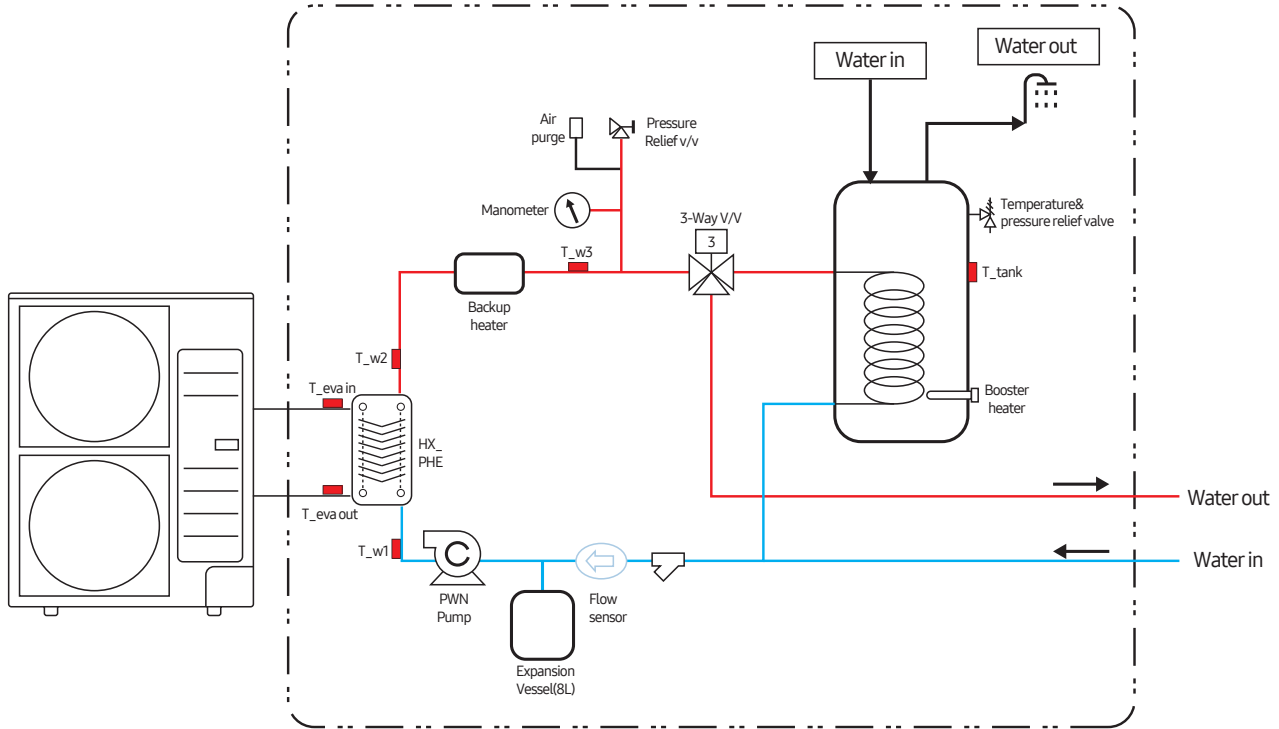

4. Installation

Tank integrated hydro unit

Application 1: Space heating + water heating

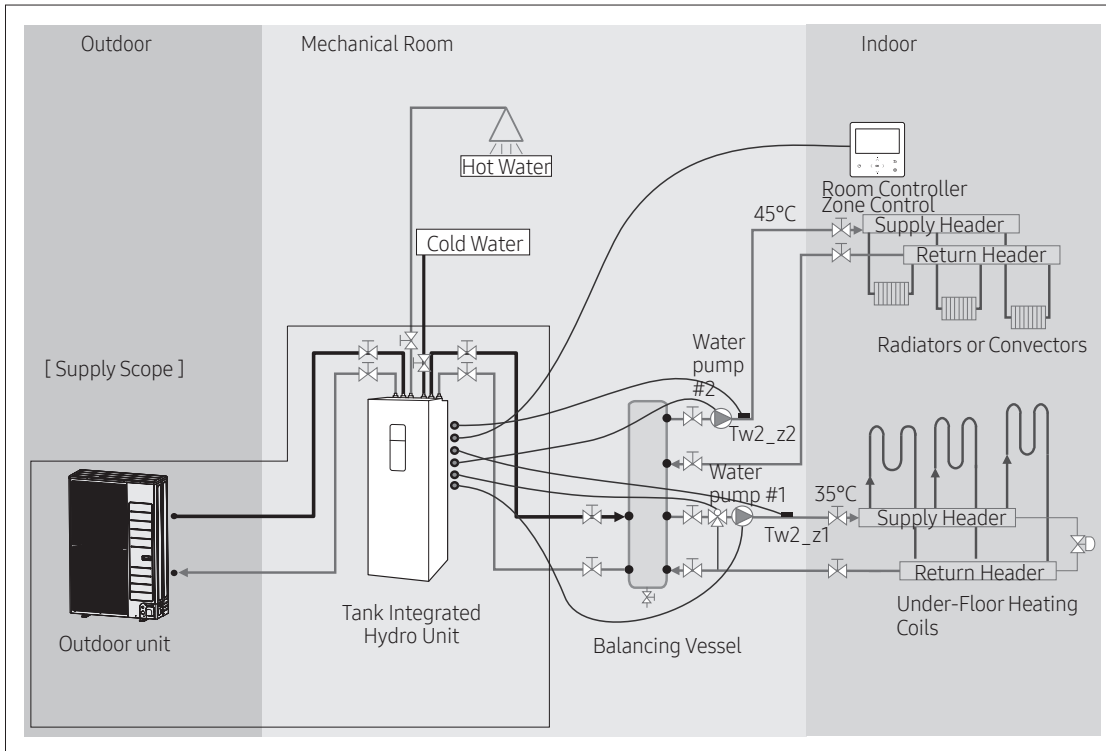

Application 2: Hybrid application (backup boiler and solar panel conected)

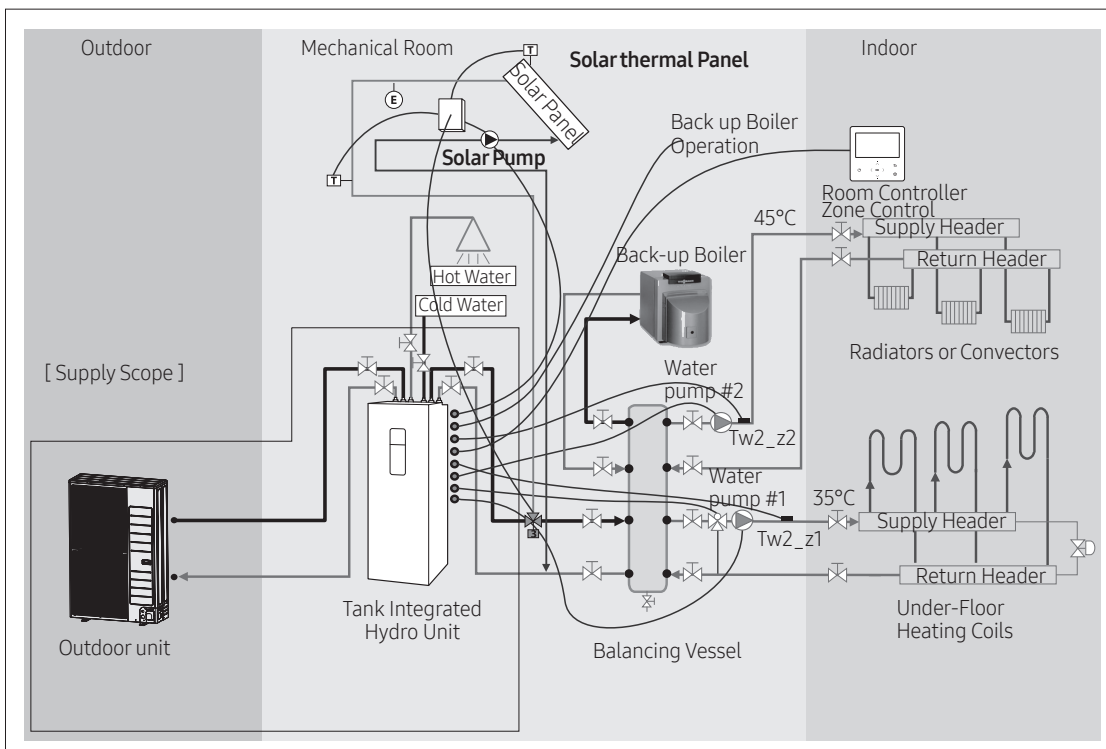

※ In case you want more information about the controllers and accessories, please refer to the Controller and Accessory TDB on pvi.Samsung.com site or Global Partner Portal site.

4. Installation

Tank integrated hydro unit

Installation of mixing valve

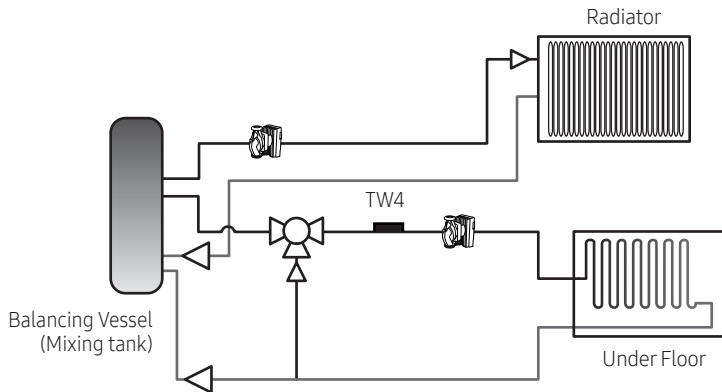

When two different zones are used with different temperature, adjust the temperature of discharge water to high temperature water and control the amount of bypass to provide low temperature water by applying the mixing valve and temperature sensor of the mixing valve (TW4).

1. Select a mixing valve from the manufacturers as below (recommended) and install it at the entrance of the zone.
2. Install the supplied temperature sensor (TW4) on the rear part of the mixing valve. Install TW4 Sensor within 1m of Mixing Valve.
3. Since running time varies depending on the manufacturer, set the FSV (default 90 sec.) by referring to the FSV value below.

Maker		BELIMO	SIEMENS	HONEYWELL
Model code	3 Way Valve	R3020-6P3-S2	VXP45.20-4 (kvs 4)	V5011E1213
	Actuator	LR230A(-S)	SSB31	ML6420A3015
Running time		90 sec.	150 sec.	60 sec.
FSV(#4046) setting		9	15	6

※ The table above is for your reference. It can be changed without advanced notice.

※ In case you want more information about the controllers and accessories, please refer to the Controller and Accessory TDB on pvi.Samsung.com site or Global Partner Portal site.

4. Installation

Tank integrated hydro unit

4. Set the FSV value by referring to the table below depending on installation environment.

Function	Details	Code	Unit	Default	Min.	Max.
Mixing valve	Use or not	4041	-	0(No)	0	2
	Target temperature difference (Heating) (TW3-TW4)	4042	°C	10	5	15
	Target temperature difference (Cooling) (TW4-TW3)	4043	°C	10	5	15
	Control factor	4044	-	2	1	5
	Interval of valve control	4045	Min.	2	1	30
	Running time (10 second unit)	4046	(x10) sec	9	6	24

- ※ 4041 =1 : Controlled based on the temperature difference (4042, 4043)
- ※ 4041 =2 : Controlled based on the temperature difference of the WL value

ex) Heating

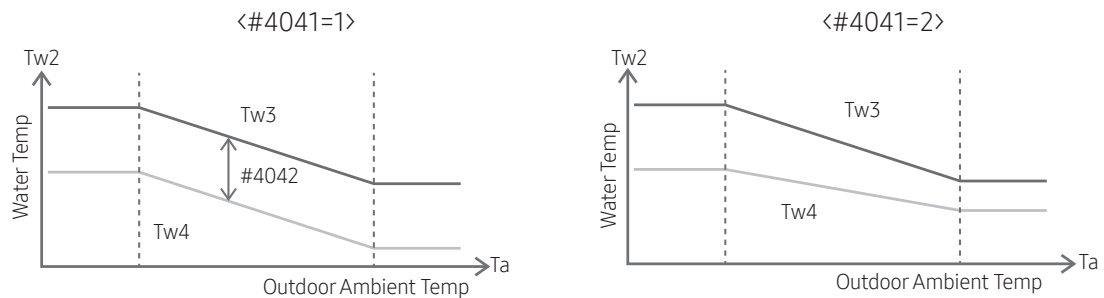

- ※ The mixing valve is controlled based on the FCU WL value.
- ※ As the #4044 value increases and the #4045 value decreases, the control speed increases. (Temperature hunting may occur if the control speed increases depending on the load.)
- ※ The additional pump and mixing valve should be purchased separately. TW4 sensor is included in the product accessories.
- ※ TW3 : Water temp. sensor 3

CAUTION

- When the thermostat control is set as 'Use', the mixing valve can be used for Zone 1 and Zone 2. (When both FSV #2091 and #2092 are set as 1/2)
- When using Zone control (FSV 4061 = 1), ignore Thermostat signal.

※ In case you want more information about the controllers and accessories, please refer to the Controller and Accessory TDB on pvi.Samsung.com site or Global Partner Portal site.

4. Installation

Tank integrated hydro unit

2-zone control using Thermostat

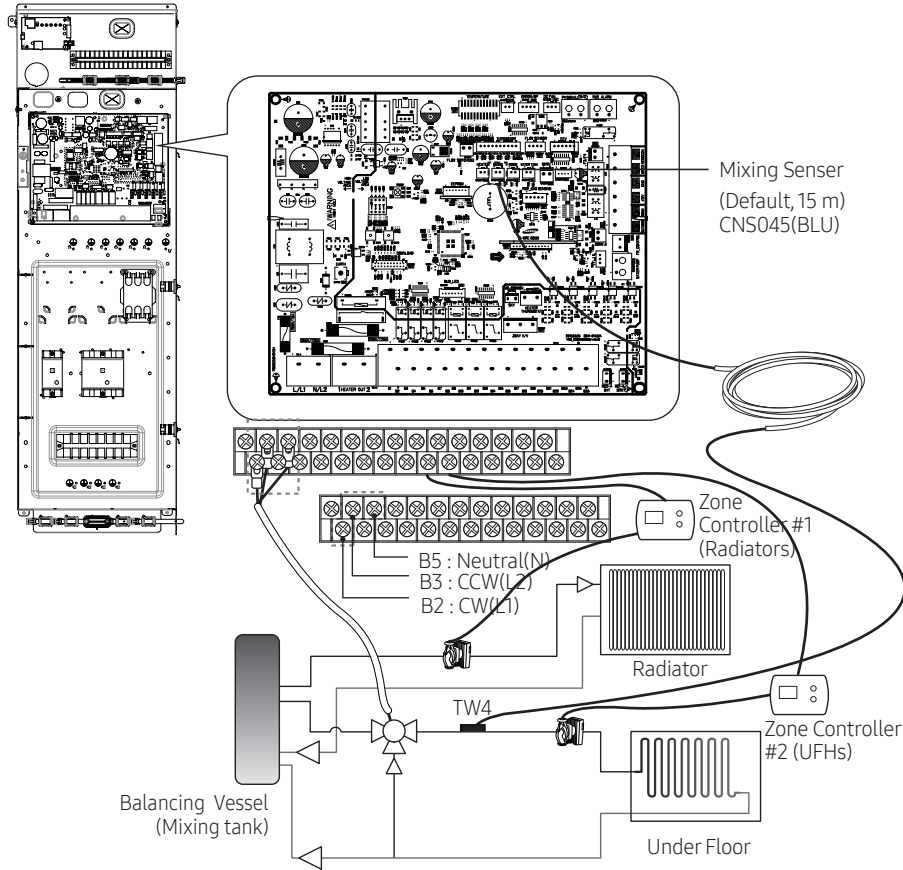

Description	No. of wires	Max. current	Thickness	Supply Scope
Mixing valve	4	22 mA	> 0.75 mm ² , H05RN-F or H07RH-F	Field supply (230 V~, Input)

1. Before the installation, hydro unit should be turned off.
2. Using the appropriate equipment to correct position of terminal block as shown on the diagram.

※ In case you want more information about the controllers and accessories, please refer to the Controller and Accessory TDB on pvi.Samsung.com site or Global Partner Portal site.

4. Installation

Tank integrated hydro unit

2-Zone Control Using Remote Controller

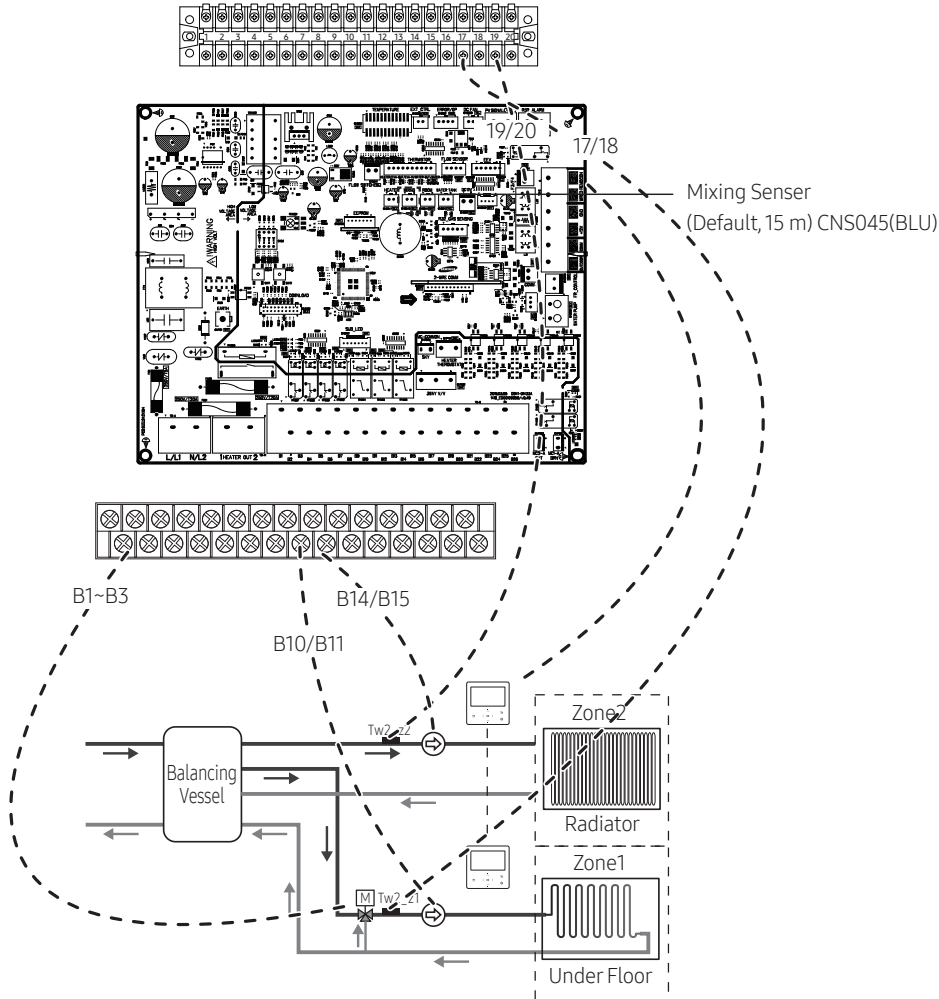

You can operate the 2-zone control using a mixing value, water-out temperature sensors, and built-in or external room temperature sensors installed in a wired remote controller.

When both zones are simultaneously Thermo on, the operation is performed based on Zone2. Therefore, set the zone that you want to have the higher set temperature to Zone2.

(The mixing valve must be installed in the zone that you want to have the lower set temperature.)

1. Install the mixing valve. (See "Installation of mixing valve.")
 2. Install the water-out temperature sensors (Tw2_z1, Tw2_z2) for all zones.
 3. Unlike the zone control with a thermostat, connect the water pump signal lines to the product.
 - Zone1 water pump connection: B10 (L1) + B11 (N)
 - Zone2 water pump connection: B14 (L1) + B15 (N)
 4. FSV 4061 = 1: Enable the 2-zone control using the wired remote controller.
- ※ If you want to operate the 2-zone control by using water-out temperatures, you have only to complete steps 1 to 4 above.
- ※ If you want to operate the 2-zone control by using room temperatures and built-in temperature sensors in wired remote controllers, you must install two wired remote controllers in each room. (If you use external room temperature sensors, you can control each room temperature with only one wired remote controller.)

※ In case you want more information about the controllers and accessories, please refer to the Controller and Accessory TDB on pvi.Samsung.com site or Global Partner Portal site.

4. Installation

Tank integrated hydro unit

Wiring work

* When you use inlet hole through the cabinet top positions for power/communication wires, please fix the wire by using mount tie of the cabinet right.

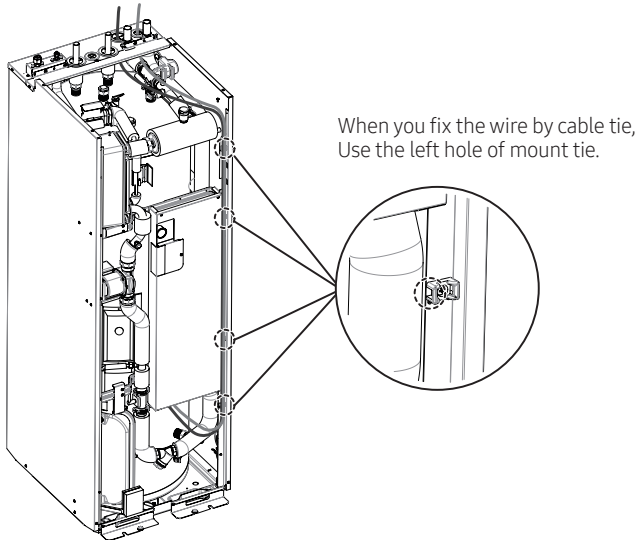

2 wires for communication cable

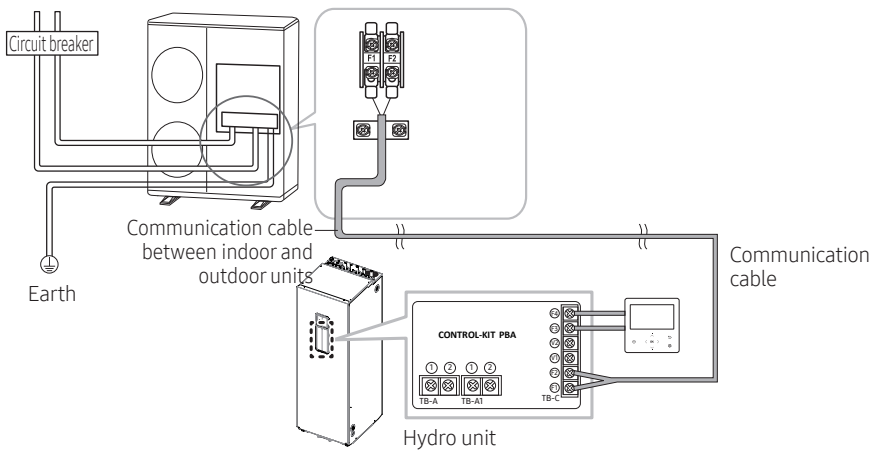

Communication cable connection

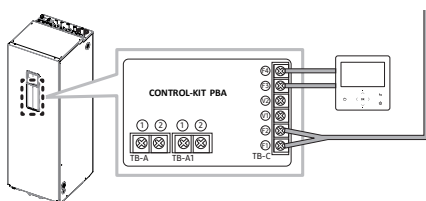

※ In case you want more information about the controllers and accessories, please refer to the Controller and Accessory TDB on pvi.Samsung.com site or Global Partner Portal site.

4. Installation

Tank integrated hydro unit

1. 1 phase product

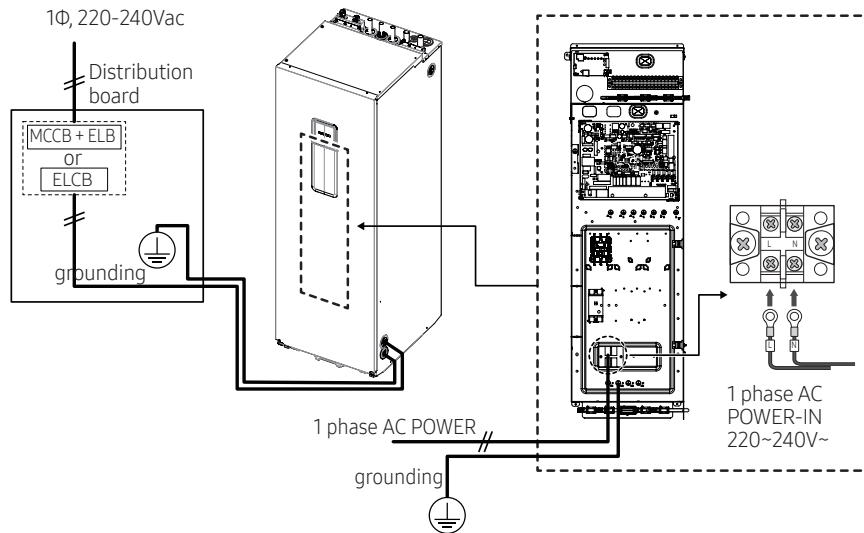

2. 3 phase product

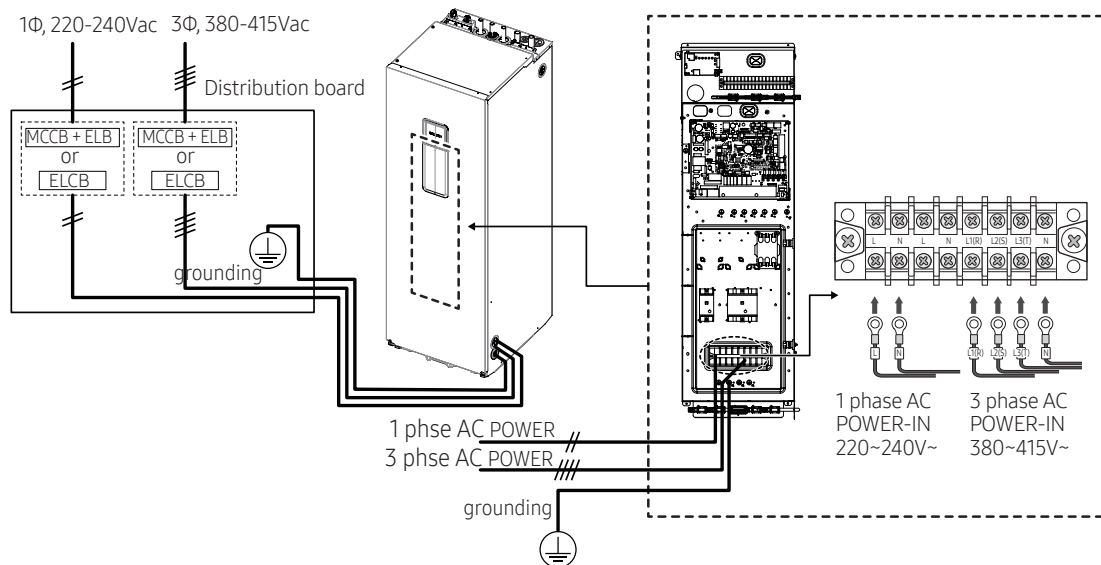

⚠ CAUTION

- If the supply cable is damaged, it must be replaced by a special cable or assembly available from the manufacturer or installer.
 - Circuit Breaker (ELCB, ELB, MCCB etc.) for outdoor and indoor units shall be installed by installers because they are not sub-parts in the units. But you don't need to install for hydro unit (Built-in ELCB).
 - It cause damage to chassis, PCB parts if the main power is not connected correctly. You should make certain that R, S, T is connected correctly before turning on the main power. (3 phase models only)
- ※ ELCB : Earth leakage circuit breaker
ELB : Earth leakage breaker
MCCB : Molded case circuit breaker

※ In case you want more information about the controllers and accessories, please refer to the Controller and Accessory TDB on pvi.Samsung.com site or Global Partner Portal site.

4. Installation

Outdoor Unit

Space requirements for outdoor unit

When installing 1 outdoor unit

(Unit : mm)

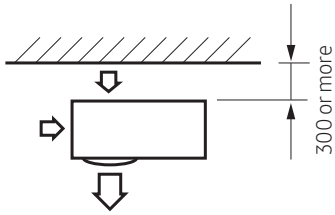

※ When the air outlet is opposite the wall

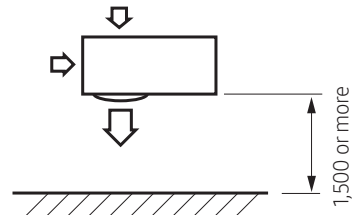

※ When the air outlet is towards the wall

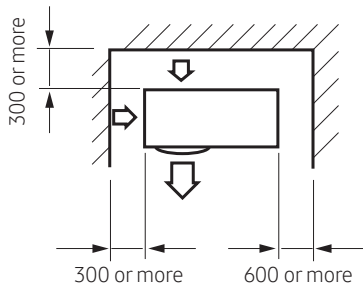

※ When 3 sides of the outdoor unit are blocked by the wall

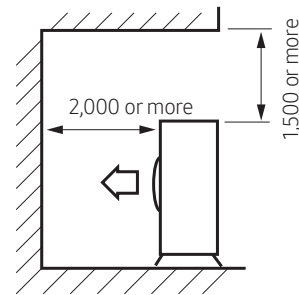

※ The upper part of the outdoor unit and the air outlet is towards the wall

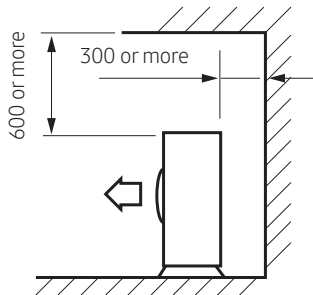

※ The upper part of the outdoor unit and the air outlet is opposite the wall

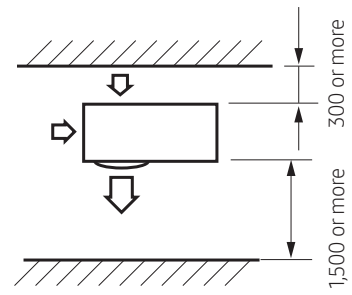

※ When front and rear side of the outdoor unit is towards the wall

※ In case you want more information about the controllers and accessories, please refer to the Controller and Accessory TDB on pvi.Samsung.com site or Global Partner Portal site.

4. Installation

Outdoor Unit

When installing more than 1 outdoor unit

(Unit : mm)

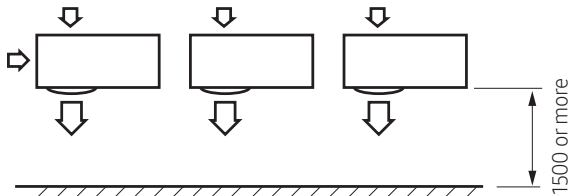

※ When the air outlet is towards the wall

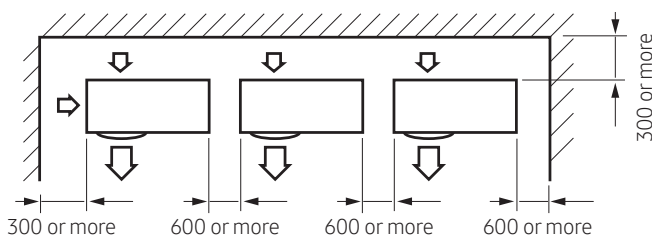

※ When 3 sides of the outdoor unit are blocked by the wall

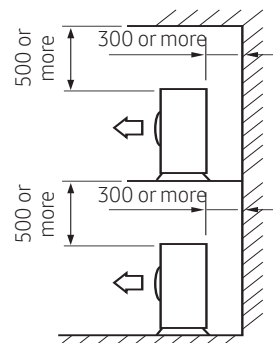
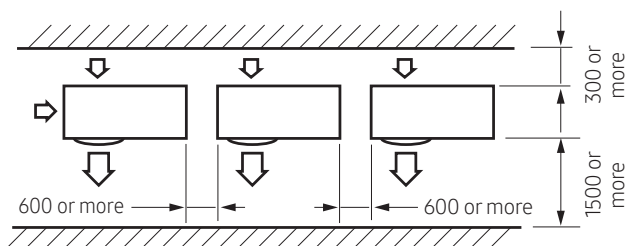

※ When front and rear side of the outdoor unit is towards the wall

※ The upper part of the outdoor unit and the air outlet is opposite the wall

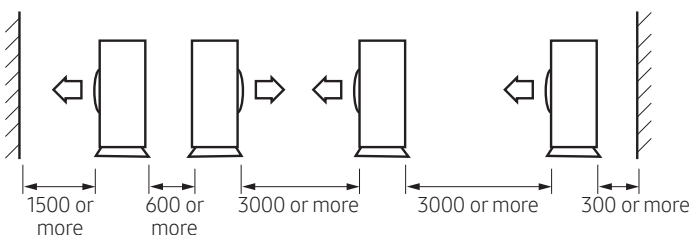

※ When front and rear side of the outdoor unit is towards the wall

⚠ CAUTION

- The units must be installed according to distances declared, in order to permit accessibility from each side, either to guarantee correct operation of maintenance or repairing products. The unit's parts must be reachable and removable completely under safety condition (for people or things).

※ In case you want more information about the controllers and accessories, please refer to the Controller and Accessory TDB on pvi.Samsung.com site or Global Partner Portal site.

4. Installation

Outdoor Unit

Outdoor unit installation

The outdoor unit must be installed on a rigid and stable base to avoid any increase in the noise level and vibration, particularly if the outdoor unit is to be installed in a location exposed to strong winds or at a height, the unit must be fixed to an appropriate support (wall or ground).

- Fix the outdoor unit with anchor bolts.

NOTE

- The mixing valve is controlled based on the FCU WL value.

CAUTION

- When tightening the anchor bolt, tighten the rubber washer to prevent the outdoor unit bolt connection part from corroding.
- Make a drain outlet around the base for outdoor unit drainage.
- If the outdoor unit is installed on the roof, you have to check the ceiling strength and waterproof the unit.

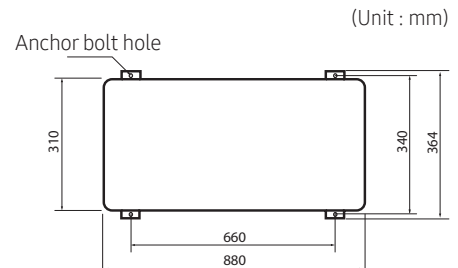
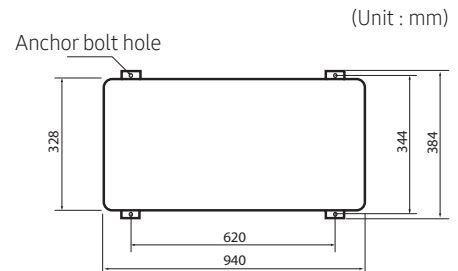

※ In case you want more information about the controllers and accessories, please refer to the Controller and Accessory TDB on pvi.Samsung.com site or Global Partner Portal site.

4. Installation

Outdoor Unit

Overall system configuration

Connection of the power cable (1 phase 2 wires)

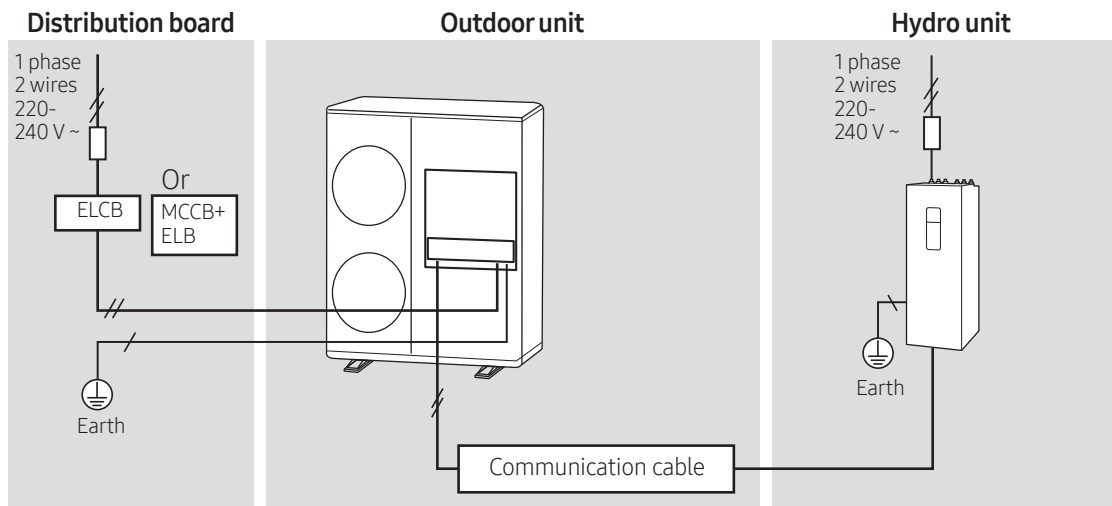

⚠ CAUTION

- Install cabinet panel near the outdoor unit for the convenience of service and emergency operation off.
- Make sure to install the circuit breaker with the over-current and electric leakage protection.

Connection of the power cable (3 phase 4 wires)

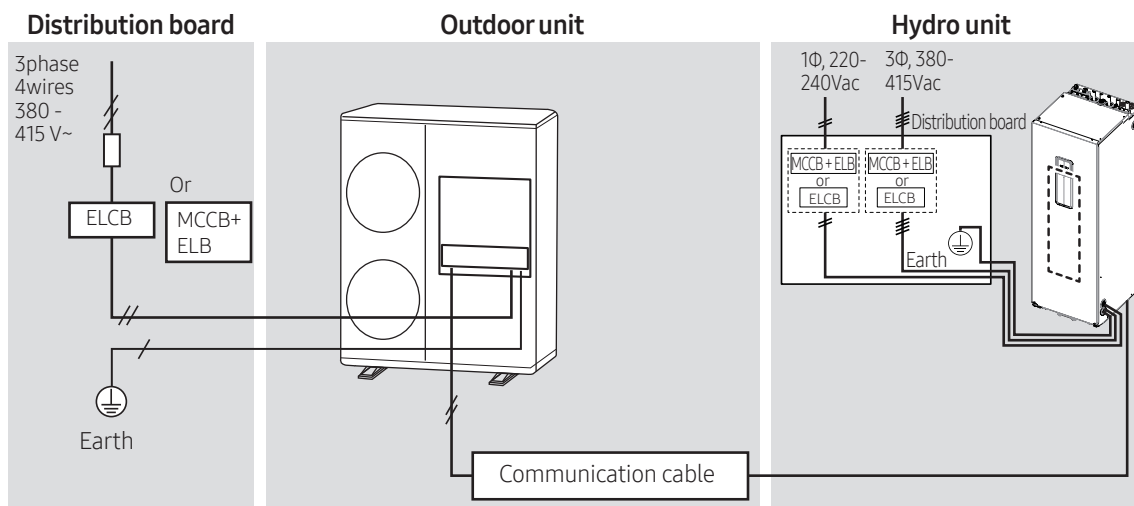

⚠ CAUTION

- Install cabinet panel near the outdoor unit for the convenience of service and emergency operation off.
- Make sure to install the circuit breaker with the over-current and electric leakage protection.

※ In case you want more information about the controllers and accessories, please refer to the Controller and Accessory TDB on pvi.Samsung.com site or Global Partner Portal site.

4. Installation

Outdoor Unit

Wiring diagram of power cable

When using ELB for 1 phase and 3 phase

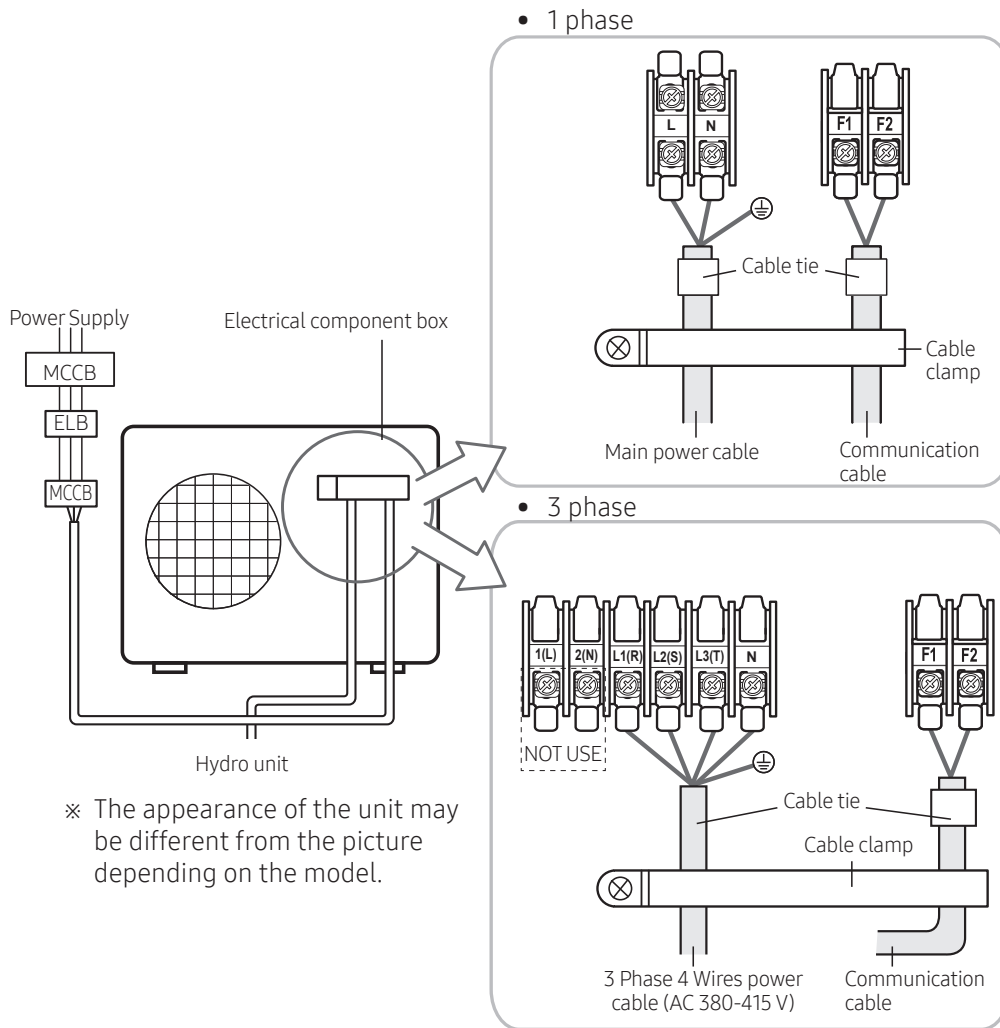

⚠ CAUTION

- You should connect the power cable into the power cable terminal and fasten it with a clamp.
- The unbalanced power must be maintained within 2 % of supply rating.
 - If the power is unbalanced greatly, it may shorten the life of the condenser. If the unbalanced power is exceeded over 4 % of supply rating, the indoor unit is protected, stopped and the error mode indicates.
- To protect the product from water and possible shock, you should keep the power cable and the connection cord of the indoor and outdoor units within ducts. (with appropriate IP rating and material selection for your application)
- Ensure that main supply connection is made through a switch that disconnects all poles, with contact gap of a least 3 mm.
- Devices disconnected from the power supply should be completely disconnected in the condition of overvoltage category.
- Keep distances of 50 mm or more between power cable and communication cable.

※ In case you want more information about the controllers and accessories, please refer to the Controller and Accessory TDB on pvi.Samsung.com site or Global Partner Portal site.

4. Installation

Outdoor Unit

1 phase 2 wires

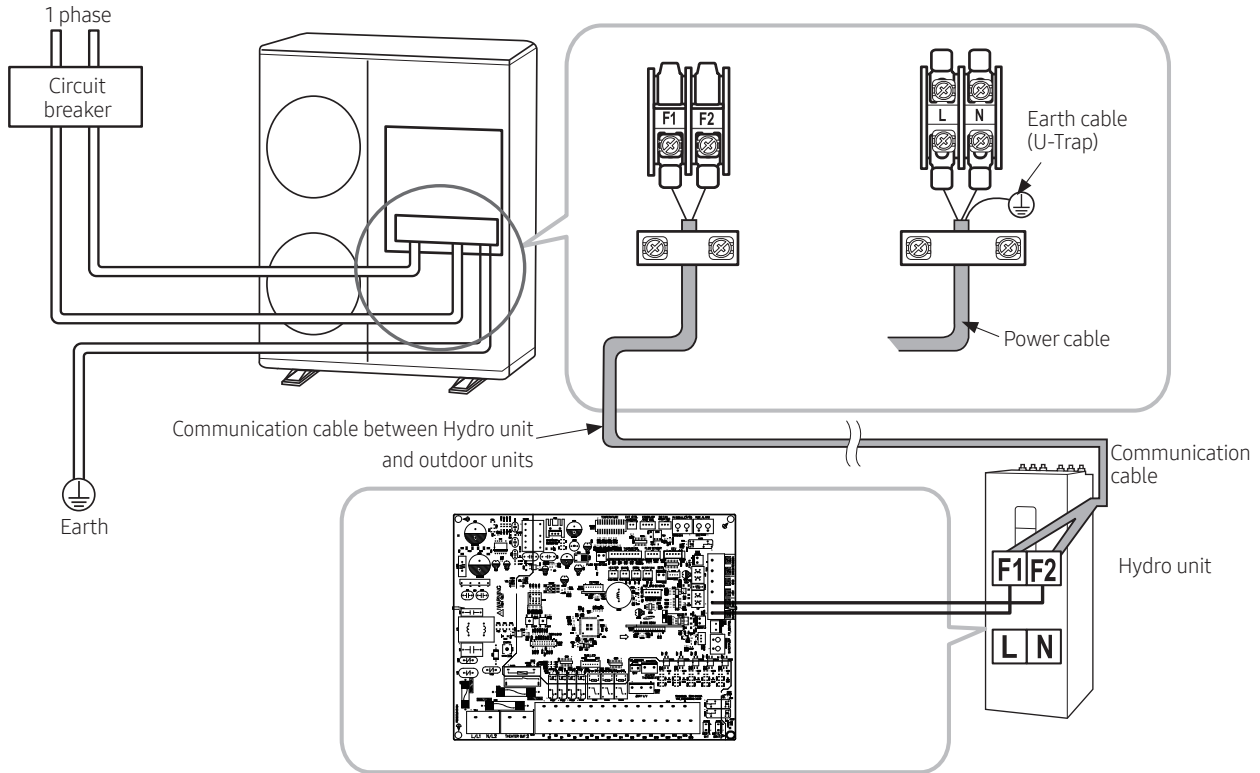

CAUTION

- When removing the outer cover of the power cable, use the appropriate tools to prevent damaging the inner cover.
- Make sure to place the outer cover of the power cable and the communication cable, at least 20 mm into the electrical parts.
- Communication wiring should be done separately from the power cable and other communication cables.

※ In case you want more information about the controllers and accessories, please refer to the Controller and Accessory TDB on pvi.Samsung.com site or Global Partner Portal site.

4. Installation

Outdoor Unit

3 phase 4 wires

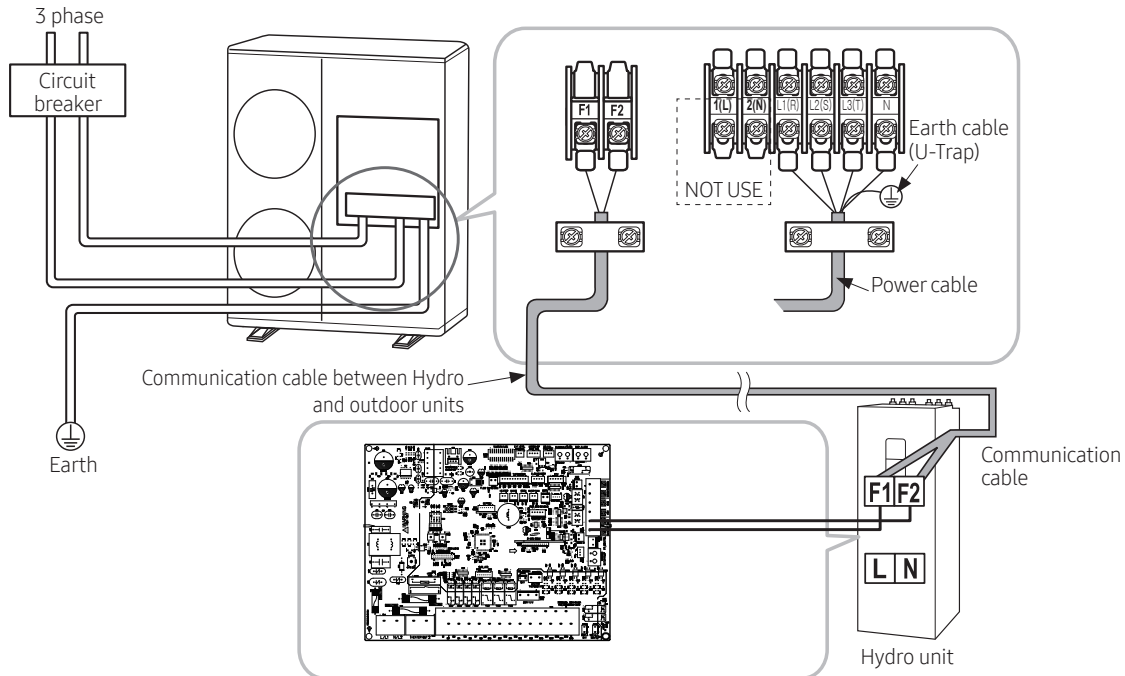

⚠ CAUTION

- When removing the outer cover of the power cable, use the appropriate tools to prevent damaging the inner cover.
- Make sure to place the outer cover of the power cable and the communication cable, at least 20 mm into the electrical parts.
- Communication wiring should be done separately from the power cable and other communication cables.

※ In case you want more information about the controllers and accessories, please refer to the Controller and Accessory TDB on pvi.Samsung.com site or Global Partner Portal site.

2019.11
Ver.1.2

Samsung Electronics Co., LTD.

Head Office (Suwon Korea) 129, Samsung-Ro, Yeongtong-Gu, Suwon City, Gyeonggi-Do, Korea 16677
Website : www.samsung.com, <https://partnerhub.samsung.com> Email : airconditioner@samsung.com
Images and data in this book may subject to change without prior notice.