

KOSPEL

Electric Central Heating Flow Boiler

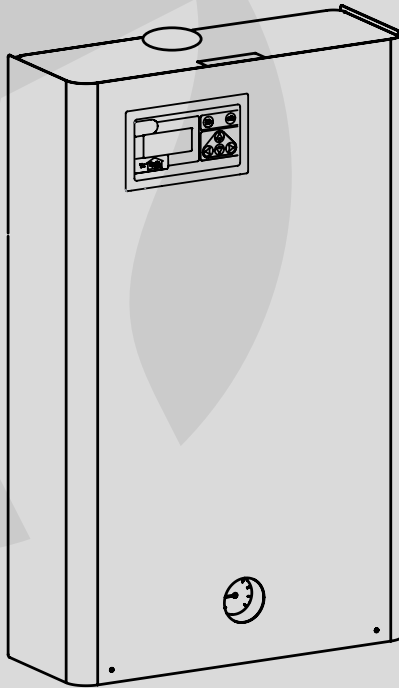

EKCO.TM

Assembly and operating instructions

Contents

Safety instructions	3
Basic information about the boiler	3

Instruction for the installer

Technical data	3
Boiler installation	4
External appliances	8
Cascade connection	9
External mode switching	10

Instruction for the user

Control panel – introduction	11
Main view	11
Display view settings	12
Language version	13
Boiler and DHW Cylinder Configuration	13
Outdoor temperature compensation	14
Automatic summer mode	15
Boiler working mode	16
Automatic work with 24h temperatures, 24h, weekly programs	16
Pump working mode	18
Setting the time	19
Room temperature sensor.	19
DHW Pump	20
DHW Cylinder	20
Heating of the second circuit	22
Central heating parameters	22
Failures	23
Extended menu	23
Cascade connection	25

Safety instructions

1. Please read and follow the Installation and Operating Instructions carefully, to ensure the long life and reliable operation of this appliance
2. The boiler installation and all electrical connections must be made by a qualified person.
3. Manufacturer may make minor changes, if necessary in the appliance that will not be shown in the operating instructions, so long as the main features of the boiler remain the same.
4. The Control Panel is pre-set by the manufacturer so it is ready to be operated, however you can adjust the manufacturer settings to your individual requirements. Appropriate programming ensures comfortable and economical operation of the boiler.
5. It is necessary to cut off all power supply using either the boiler switches or switching off the fuse prior to removing the boiler front casing.
6. Do not drain the water from central heating system after the heating season.
7. In buildings where the boiler is operated only on temporary basis and the heating installation can be exposed to frost, the boiler must be operated at all times using anti-freeze mode, or the heating installation must be protected using an anti-freeze liquid.

Basic information about the boiler

The provided installation and operating instructions refers to the following boiler types:

- EKCO.TM– wall-mounted electric boiler, single-functional, with the weather compensation, enable to cooperate with one or two central heating circuits (e.g. radiators and under-floor), with the DHW cylinder and the central heating flow pump.

The boilers mentioned above shall be operated on a closed (unvented) central heating installation with a forced water circulation, protected in accordance with the binding norms and standards. The boilers can also work on opened (vented) central heating installations with forced circulation protected in accordance with the binding norms and standards.

They are equipped with a front control panel, which takes into consideration current outdoor temperature. This feature ensures an almost automatic operation of the boiler. Accurate setting of the heating parameters ensures economical operation of the boiler.

The boiler is equipped with a circulating pump, a manometer and an automatic vent valve .

The boiler is also equipped with a number of other safety devices:

- flow control system,
- inner temperature sensor,
- temperature cut-out and safety valve.

The power of the boiler should be adjusted according to the heat loss of the heated building.



This appliance may be used by children at the min. age of 8 years and by persons with reduced physical, sensory or mental capabilities or lack of experience and knowledge about the product, provided that they have been given supervision or instruction concerning safe usage of the appliance and that they are aware of potential dangers that might result from usage of the appliance. Children should not play with the device. Children without supervision should not complete any cleaning nor maintenance procedures.

Technical data

Maximal pressure	MPa	0,3
Minimal pressure	MPa	0,05
Outflow water temperature	°C	20 ÷ 85
Max. water temperature	°C	100
Dimensions (height x width x depth)	mm	815 x 503 x 197
Weight	kg	~29
Water connections		G 1"
Safety class		IP 21

Boiler type		EKCO.TM			
Rated power	kW	30	36	42	48
Rated voltage		400V 3N~			
Rated current	A	3 x 43,3	3 x 52,0	3 x 60,6	3 x 69,3
Fuse rated current	A	50	63	80	
Minimal connecting wires section	mm ²	5 x 10			5 x 16
Maximal connecting wires section	mm ²	5 x 50			
The maximum allowed network impedance	Ω	0,14	0,09	0,035	0,03

Boiler installation

Installation conditions

- an appropriate power supply,
- an efficient electrical installation which has been completed in accordance with the binding norms of electric installation,
- wet central heating system equipped with an appropriate expansion vessel made according to the binding norms of hydraulic installation,
- the heating installation needs to be flushed thoroughly before the installation,
- the boiler must be protected from dirt by using a magnetic filter,
- do not install any barrier fittings (e.g. valves) on the outlet of the safety valve,
- this appliance must not be installed in a humid place or in a place exposed to the danger of explosion,
- if the boiler is to co-operate with an under-floor heating system protecting fittings must be installed (fig.2b or 3).

A magnetic filter must be installed on return pipe of central heating installation system (before boiler inlet). The filter must be installed in horizontal position, accordingly to flow direction (see arrow on the filter body), with the magnetic insert chamber to the bottom.

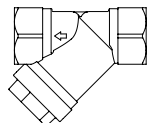

Installation work

1. Hang the boiler up in a vertical position on fixing screws with inlet and outlet pipes to the bottom, maintaining clearances from the walls and the ceiling (see fig.1).
2. Connect the boiler to a central heating system equipped with cut-off valves (see fig.2 & fig.3).
3. Fill the central heating system with a treated water, that extends the life of the heating elements.
4. Vent the central heating system.
5. Connect a boiler to the electrical system (see fig. 4).

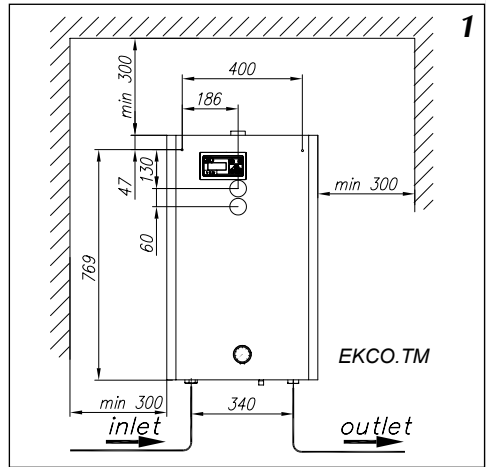

Fig.1 Fixing the boiler to the wall

Important

The control panel allows for its co-operation in different central heating systems, however the control panel needs to be set accurately (see „Front control Panel“ „Extended Menu“). e.g. if the boiler only co-operates with an under floor heating system, a Tcomax (max. temperature in the central heating system) must be set at 60°C and WCHG (radiator coefficient) at „Pod“ (see „Extended Menu“ on page 24).

Special start-up procedure

A flow rate reading error may occur if you start-up the unit at low ambient temperature. This error may occur because the physical properties of antifreeze solution.

Under this circumstances, the special start-up procedure will start if you:

- activate the central heating or cylinder heating mode using the control panel display (see fig.14),
- close the NA entry on ZIO board (see fig.5),
- notice the „!“ (an exclamation mark) at main view panel display (see „Failures“ page 12).

As a result, the medium will be warmed up to temperature that enabled you to read the flow rate correctly. The duration of procedure depends on both the installation capacity and the temperature inside the system.

When the main view panel display (fig.10, 11) and the central heating parameters view (fig. 31) shows boiler power value and („-“, „--“) alternately it means that the procedure is started.

The procedure will switch off automatically and the unit will start normal operation once the minimal flow rate is reached.

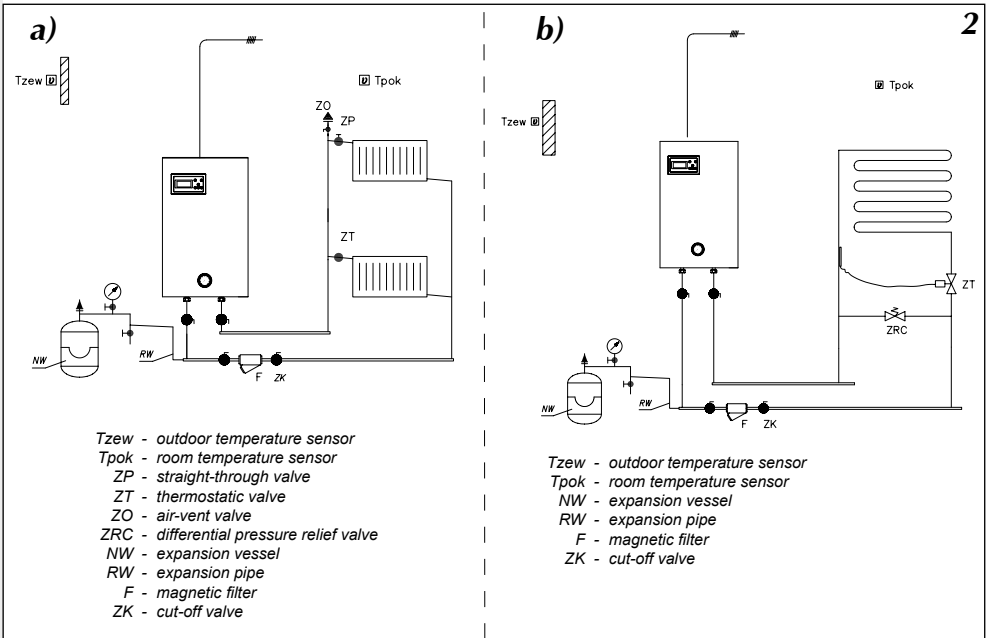

Fig.2 Exemplary scheme of central heating system
 a) - radiators system (one heating circuit)
 b) - under-floor heating system (one heating circuit)

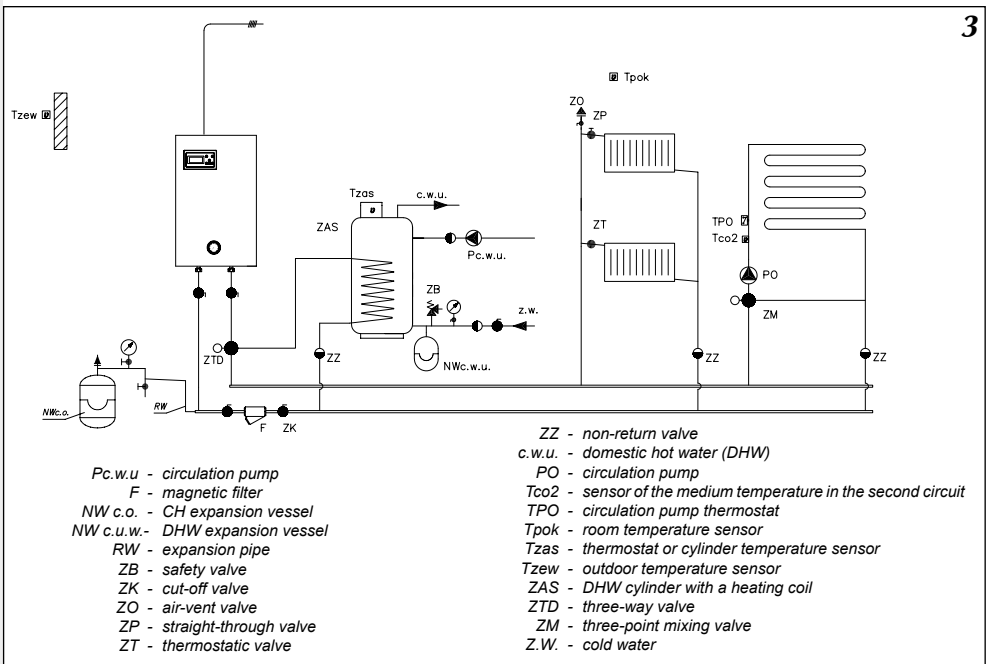

Fig.3 Exemplary scheme of central heating system— radiators, under-floor heating, DHW cylinder, DHW circuit

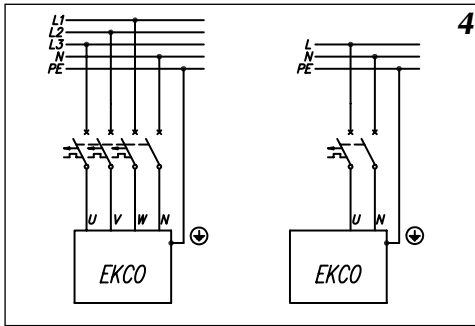

Fig.4 Connection to the electric mains

Electric installation should be equipped with residual current protective devices and other solutions which will ensure disconnecting the unit from the source of power (intervals between all their poles should not be less than 3 mm).

External appliances

A number of other appliances or necessary sensors (fig. 5) can be connected to the boiler according to the individual requirements. The temperature sensors should be connected using a LIYY 2x0,14 or similar type of wire. Pay special attention to the sensors ending, incorrect wiring may result in short circuit. The connecting wire lengths must be limited. A long wire may cause interference and faulty sensor operation. The wires must not be run in the same conduit with (or too close to) electrical wiring, and must not be wrapped around any other wires or cables. The sensor location is essential for its proper functioning. Outdoor temperature sensor should be installed in the coolest place in the building (north building side), relatively far away from the heat source (e.g. windows that can be opened, ventilation ducts, chimneys and other heated surfaces). Do not install the outdoor sensor in the place exposed to direct sunshine. Indoor temperature sensor must be located inside the building, in the most commonly used room, relatively far away from windows, radiators, doors and other places that may have affect on correct temperature measuring. The indoor temperature sensor is optional accessory. For more information about sensor see page 19 - „Room temperature sensor“.

Connecting external appliances to the ZIO module

A number of other appliances or necessary sensors (fig. 5) can be connected to the boiler according to the individual requirements. The temperature sensors should be connected using a LIYY 2x0,14 or similar type of wire. Pay special attention to the sensors ending, incorrect wiring may result in short circuit. The connecting wire lengths must be limited. A long wire may cause interference and faulty sensor operation. The wires must not be run in the same conduit with (or too close to) electrical wiring, and must not be wrapped around any other wires or cables. The sensor location is essential for its proper functioning. Outdoor temperature sensor should be installed in the coolest place in the building (north building side), relatively far away from heat source (e.g. windows that can be opened, ventilation ducts, chimneys and other heated surfaces). Do not install the outdoor sensor in the place exposed to direct sunshine. Indoor temperature sensor must be located inside the building, in the most commonly used room, relatively far away from windows, radiators, doors and other places that may have affect on correct temperature measuring. The indoor temperature sensor is optional accessory. For more information about sensor see page 19 - „Room temperature sensor“.

Master appliance – you can limit the boiler electricity consumption by connecting the master appliance (e.g. instantaneous water heater) – see fig.5. The master appliance must be equipped with the relay output. The output should be connected to the NA entry in the ZIO board by using LIYY 2 x 0,14 or similar type of wire.

Do not connect any voltage to NA entry! Use an appropriate relay if the master appliance can control the voltage signal only. **NA entry must remain closed if not used!**

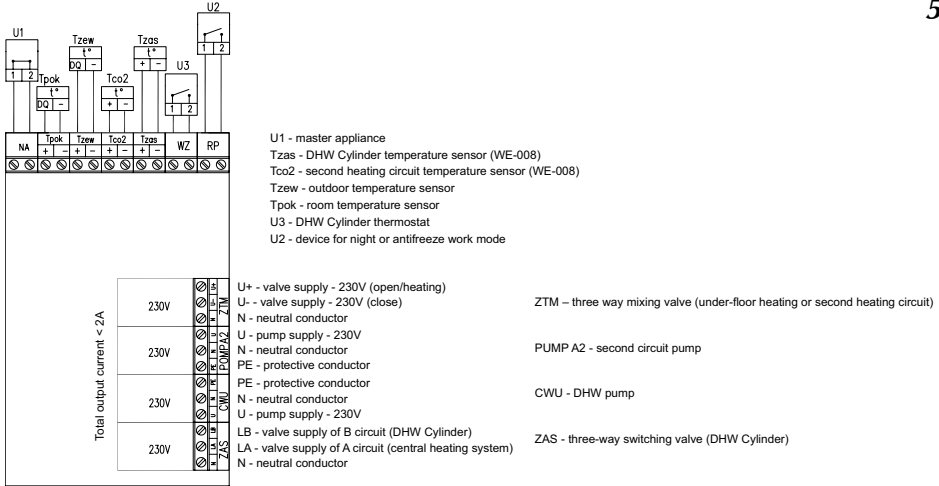

Fig.5 Connecting external appliances to the ZIO board

Please refer to the appropriate section of this manual for ZIO board work details.

DHW temperature reading

Controller can measure a water temperature for:

- cylinder thermostat equipped with a free voltage output.
- cylinder temperature sensor (WE-008 offer by Kospel S.A.- optional equipment) Set the „Extended Menu” for option a or b. For thermostat contacts and cylinder sensor connection details see fig.5.

Three-way valve connection (DHW Cylinder)

Switching the boiler operation to central heating or heating water in the coil of DHW cylinder is carried out using a three-way dividing valve with an actuator. Depending on the model used, the device should be connected as shown on the diagrams, page no. 8 and the manual of valve and servomotor.

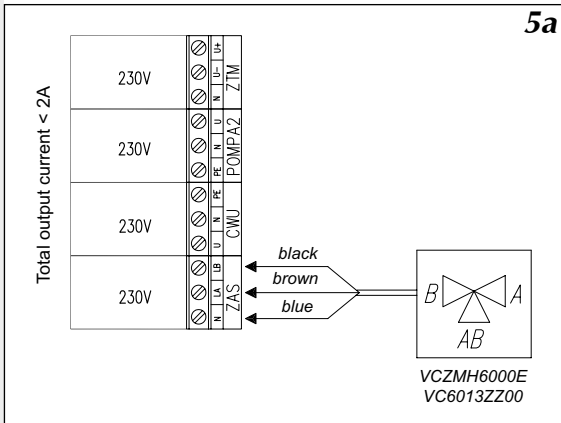

Fig.5a Honeywell valve connection diagram

DHW pump

The boiler is able to control DHW pump. The pump operation can be set to meet the individual needs (24hours program). The pump should be connected to ZIO board as shown in fig.5 (page 8). The pump is supplied with 230V.

Connecting the mixing valve of the second circuit.

The ZTM contacts of ZIO22 board enables to connect the mixing valve with 3 point drive to supply the second heating circuit (fig.3 ZM valve). This circuit must be adjusted to the lower parameters than the circuit of the boiler e.g. when the circuit of the boiler is set for the maximum temperature of 85°C (see the „Extended Menu“ for WChG, WChG2, Tcomax and Tc2max parameters), the second circuit can supply the underfloor heating system with the maximum temperature of 60°C. In this case it is necessary to remember that the extra safety devices has to be installed to prevent the overheating of the second circuit. The WE-008 sensor measures temperature of the second heating circuit.

Cascade connection

You can connect number of boilers to increase power. The maximum number of slave unit (ECKO.T) in cascade is 8. The slave unit must be equipped with a special controller to enable cascade connection. For hydraulic connection details see fig.5.

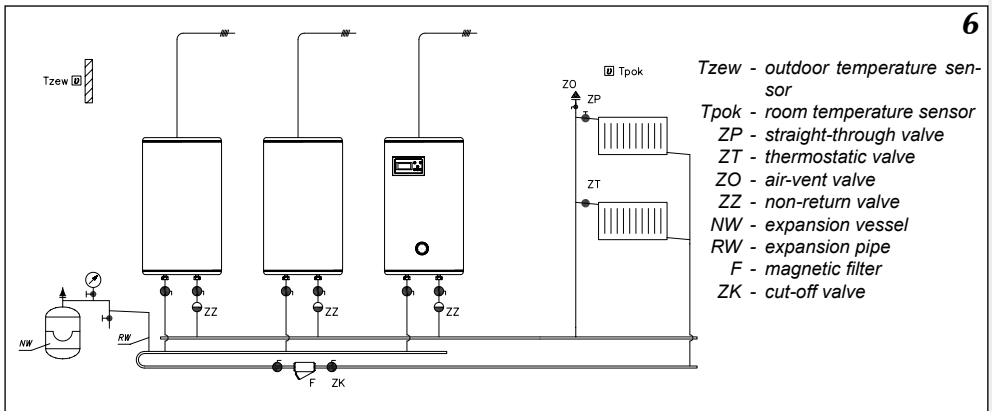

Fig.6 Boiler in cascade connection

To set the EKCO.TM to work in cascade change the „Nr” parameter in the „Extended Menu” for a required number of slave boiler.

To set the EKCO.T to work in cascade the „Extended Menu” settings have to be changed:

- a) set for „r1”
- b) set up the unit address – e.g. „A1”

The boiler address is a number that inform about the boiler in the network connection. Each boiler has its own address. The address number can not be higher than number of slave boilers. For example: if you build boilers cascade system with the EKCO.TM (as a master appliance) and three other boilers (as a slave appliances), the slave appliance should have the following addresses: A1, A2 and A3.

The boilers must be connected into the mains (use e.g. LIYY 2 x 0,14 wire). See fig.7.

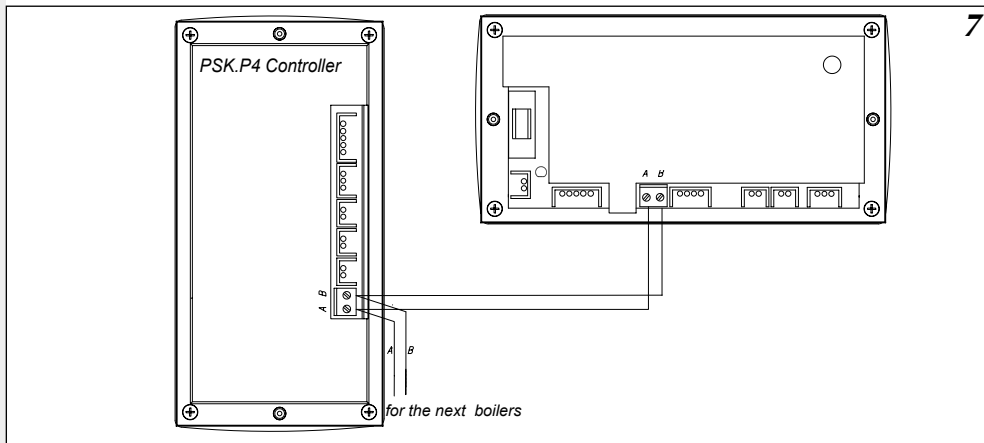

Fig.7 Additional electrical connection for boilers in cascade

The boilers must be connected in the row.

External mode switching

There is RP entry on ZIO board. Close the RP input if you need to switch to antifreeze or night time operating mode. Set-up the „Extended Menu” to select mode. Do not connect any voltage to RP entry! This entry allows connecting the external controller with the relay output and simplified boiler controlling by mobile phone.

Control panel – introduction

There is a control panel (fig.8) that enable user to boiler control.

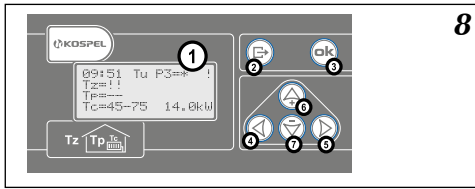

Fig.8 Control panel
1 - display
2-7 - push-buttons

When you switch boiler on, the controller gets reset (fig.9) and the display will show you the software number.

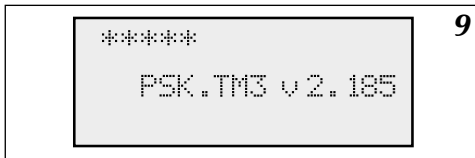

Fig.9 Controller reset

Main view

After the reset operation, the controller automatically switches to the „Main View“. The main view can display a configuration as below (depend on current mode). For more details about the boiler configuration see page 13 – „Boiler and DHW Cylinder configuration“

The boiler can co-operate with both the CH circuit and DHW Cylinder or any of them individually.

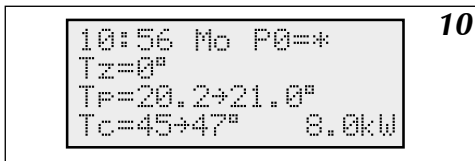

Fig.10 Main view in configuration „CH ON – DHW ON“ (central heating mode „on“ and domestic hot water mode „on“) or „CH ON-DHW OFF“ (central heating mode „on“ and domestic hot water mode „off“)

If the CH mode is „on“ the main view displays information as shown in fig.10.

I row – current time and day - GG:MM DT and current working mode (see page 16 „Working mode“).

Working mode marks:

PX – 24h program X (e.g. P0 – program no. 0), after an equal sign (=) you can read a 24h temperature.

For 24h programs details see page 16 – „Automatic working mode (24h, weekly programs)“

- „antifreez“ - anti-freeze program
- „manP5“ - program no 5 (fixed outlet temperature)
- „man+“ - fixed daily temperature program + (higher)
- „man-“ - fixed daily temperature program – (lower)
- „man*“ - fixed daily temperature program
- „man (“ - fixed night temperature program

II row - current outdoor temperature

III row - current room temperature, after (→) you can read a desire temperature

IV row – current boiler inlet temperature, after (→) you can read a set-point of outlet temperature.

At the bottom right corner you can read current boiler power (kW) or special start-up procedure mark (see page.5)

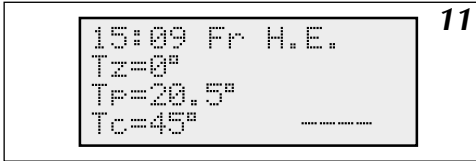

Fig.11 Main view in configuration – CH „off” and DHW „on”

If the CH mode is „off” and the DHW mode is „on” the main view displays information as shown in fig.11
 1 row - DHW mode. The power is shown only, when the boiler heats the DHW . In the last row you can see: TZ mark - DHW heating mode is „on”.



Fig.12 Main view in configuration – central heating mode „off” and DHW mode „off”

If both the central heating mode and the DHW mode is „off” the main view displays information as shown in fig.12.

Faults

Main view shows some information about faults.

- „!!” - sensor failure.
- „??” - transmission failure between controller and sensor or an extremely high temperature sensor reading (over 45°C), e.g. when the sensor is placed directly on sunshine.
- „-” - room sensor missed. It's not an error as the room sensor is optional equipment.

Main view can show „!” mark that inform you about the flow failure. This failure is only possible when the circulation pump is active.

Display view settings

There are push buttons (see fig.8) on control panel to set the display view and parameters.

After 30 seconds (if you don't use any button) the display view automatically returns to the main view and the back light turns off. (⏪) is an exit key – enables to return to the previous view or to the main view.

If you are in the main view use an appropriate push button to access to the next page:

- (⏮) – to the „24h modes”,
- (⏭) – to the CH parameters view
- (⏪) & (⏩) to other pages.

Press (⏩) to go to:

- Mode
- Config.
- Time
- Edit
- Curve
- Tp - hysteresis
- Maximum Tz
- CH pump
- DHW pump
- DHW Cylinder (1)
- DHW Cylinder (2)
- CH Circuit #2
- Error
- Extended menu
- Week mode
- ABC
- 24H temperatures

Press (⏪) to return to the previous page.

Language version

To change the language menu go to the „ABC” page. The menu is available in the following languages:

- Polish
- English
- Russian
- French

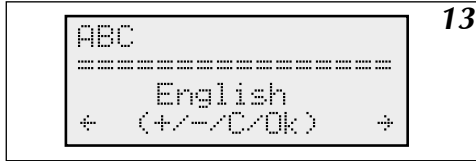

Fig.13 Language page

Push- buttons specification:

– return to the main view	– go to the next page
– save language version	– select language version
– return to the previous page	– select language version

Boiler and DHW Cylinder Configuration

Boiler can co-operate with both the DHW Cylinder and central heating system. Configuration page is shown in fig.14

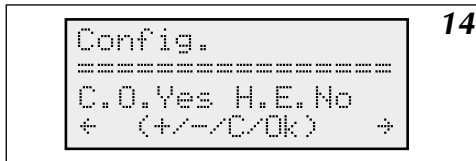

Fig.14 Configuration view

C.O. YES – CH 'on'
C.O. NO – CH 'off'
H.E. YES –DHW Cylinder (Heat Exchanger) 'on'
H.E. NO - DHW Cylinder (Heat Exchanger) 'off'
To change configuration press or .

Push- buttons specification:

– return to the main view	– go to the next page
– save changes	– on/ off central heating circuit
– return to the previous page	– on/off DHW heating

Important! Make sure you save your changes by pressing button.

Outdoor temperature compensation

The main function of PSK.M3 Controller is to maintain the proper CH medium temperature level in relation to outdoor temperature. Heat demand of building rises quickly with the dropping outdoor temperature. The exemplary relationship between the outdoor temperature and the temperature of CH medium is shown in fig.15.

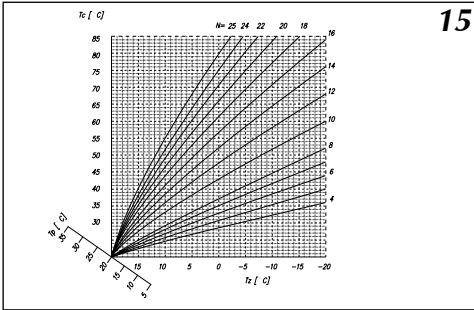

Fig.15 Heating curve

- N - the slope of a curve
- Tc - temperature of CH medium
- Tz - outdoor temperature
- Tp - room temperature

The heating curve is loaded into memory of controller. „Tp” axe can be used to move the curve to the desired room temperature. The fig.15 shows the group of heating curves for different „N” parameters and the room temperature of 20° C.

The slope of the curve (N) depends on heat loss of building. When the building is well isolated the N parameter will be accordingly low and vice versa. The N parameter is factory pre-set to value of 14 and should be appropriate for the majority of nowadays’ buildings (radiators heating). For the under floor heating the recommended value is 8.

Setting the heating curve

To set „N” value go to „Edit” page (see fig 16). The „N” value range is 4-25.

Example: The factory preset value of 14 informs that CH medium temperature reaches 20°C degree (Tpok = 20°C) when Tc = 76°C and Tzew = -20°C.

Increase the N value if the room temp. is too low. Reduce N value in the case of rooms overheating.

For more information about „N” value refer to section „Heating curve” (fig.17, page 15). To change N value press

⬆ or ⬇

Instruction for the user

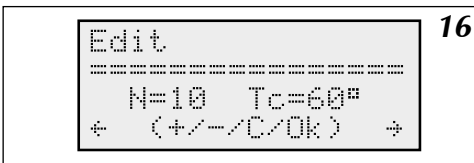

Fig.16 Heating curve edit page

The display shows the calculated value of heating medium in the current outdoor temperature mode.

This value is calculated from the „24 hour temperature”. For more information about the „24 hour temperature” value and others temperature values refer to the next pages. Important! Make sure you save your changes by pressing Ⓜ button.

Push-buttons specification:

Ⓜ – return to the main view

▶ – go to the next page



Ⓜ – save changes

▲ – increase N value

◀ – return to the previous page

▼ – decrease N value

Heating curve

To change Tz value press  or . The controller calculates the temperature of CH medium on the basis of daily temperature and „N” value.

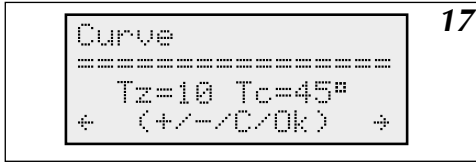

Fig.17 Heating curve

Push-buttons specification:

	– exit key to the 'Main view'		– next page
	– not applicable		– outdoor temperature – increase
	– previous page		– outdoor temperature – decrease

Automatic summer mode

The „Maximum Tz” page (fig.18) enables to set the outdoor temperature limit value. Reaching or exceeding the limit value will switch „off” boiler operation automatically.



Fig.18 Outdoor temperature limit

Push-buttons specification:

	– return to the main view		– go to the next page
	– save changes		– increase max. Tz value
	– return to the previous page		– decrease max. Tz value

Boiler working mode

The „Mode” page enables to set an appropriate working mode of the boiler (see fig.19).

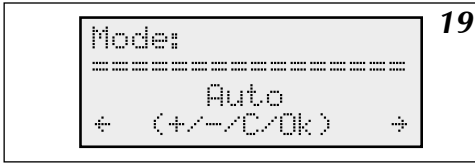

Fig.19 Working mode

Working modes of boiler:

- Auto – automatic work mode
- Always- daily temperature mode – (lower)
- Always* - daily temperature mode
- Always+ - daily temperature mode + (higher)
- Always (- night temperature mode
- AlwaysP5 – program no. 5 work mode
- antifreez. – antifreeze work mode

Push-buttons specification:

 – return to the main view	 – go to the next page
 – save changes	 – go to the next work mode
 – return to the previous page	 – return to the previous work mode

Instruction for the user

Automatic work with 24h temperatures, 24h, weekly programs

A controller is enable to load into its memory up to 4 values of estimated room temperature. (see fig.20).

- „+” daily temperature + (higher)
- „*” daily temperature
- „-” daily temperature– (lower)
- „(” night temperature

You can set the above temperatures to any value.

Important! The „daily temperature +” must be set at the highest value and the „night temperature” at the lowest.

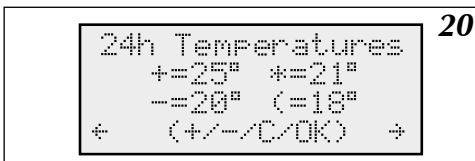











Fig.20 24h temperatures settings

To change temperature value press  or .

Push-buttons specification:

 – return to the main view	 – go to the next page
 – save changes, go to the next mode	 – increase temperature value
 – return to the previous page	 – decrease temperature value

Important! Make sure you save your changes by pressing  button.
 To build an appropriate 24 h program you have to assign daily temperatures for relevant hours. There are eight (8) 24 h programs loaded into controller memory. You can edit 2 programs only. To enter into 24 h program mode press  (when you are in the main view display).

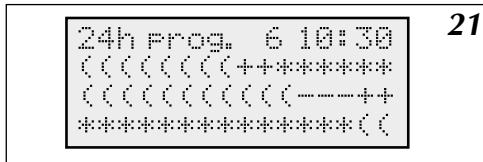







Fig.21 24h program

- '+' - daily temperature + (higher)
- '*' - daily temperature
- '-' - daily temperature – (lower)
- ('' - night temperature

To change program press  or  0-4 Programs – modification is not available
 5 Program – fixed CH medium temperature (irrespective of outdoor temperature)
 6-7 Programs – user editable programs

Each program has its own mark e.g „+“. Mark position relates to a given 30min within 24hours.







If you point at any mark, a corresponding hour will be displayed in the right upper corner of the display.

To edit/view 24 h program press  or  If you point at any mark you will see the related hour (at the right upper corner). To change the mark press  or .







Important! Make sure you save your changes by pressing  button.

Push- buttons specification:

If the courser is pointed at program no

 – return to the main view
 – save changes
 – go to the 24h program (time:23.30)
 – go to the 24h program (time:00.00)
 – go to the next 24h program
 – go to the next 24h program

If the courser is pointed at hour

 – to point at program no
 – save changes
 – go to the previous hour edition
 – go to the next hour edition
 – to change temperature related to a given hour
 – to change temperature related to a given hour

Program no 5 is editable only to set the CH medium temperature (you can set a temperature the same way as for other 24h programs) „Week program” enables to assign one of the 24h eight programs for relevant day of the week. See fig.22



Fig.22 Week program

There are numbers 1,2,3,4,5,6,7. The numbers relate to day of the week (e.g. no 1- Monday) „Prog.” shows the related daily program number.

The cursor shows current 24 h program number. To change program press or To save the changes and proceed to the next program press .

Push- buttons specification:

– return to the main view	– go to the next page
– save program no., go to the next program	– to change 24h program no
– go to the previous page	– to change 24h program no

Instruction for the user

Pump working mode

To set the pump working mode go to page „Pump mode”

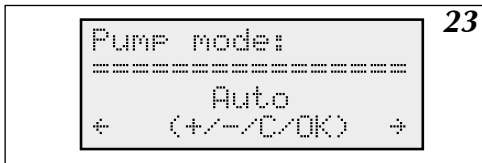

Fig.23 Pump working mode

There are two working modes of pump:

- automatic work mode
- continuous working mode

Push- buttons specification:

– return to the main view	– go to the next page
– save changes	– to change pump work mode
– go to the previous page	– to change pump work mode

If you select „Auto” work mode, the pump will stop operation in the case of:

- a) room temperature reaches the desired value,
- b) NA contacts are opened (master appliance is „on”),
- c) outdoor temperature reaches or exceeds maximum outdoor temperature (Tz Maximum value).

Important! Pump stops working after 90 sec.

Irrespective of working mode, the pump is activated once every 24hr for 1 min. (it protects a unit and CH system against silting up). The pump activation time: 12.00.

Both the CH pump (built-in) and the second circuit pump „Pump2” (connected to the „Pump2” connectors) run simultaneously. The second pump is controlled the same way as the CH pump.

Setting the time

To set the current time go to page „Time” (fig.24)

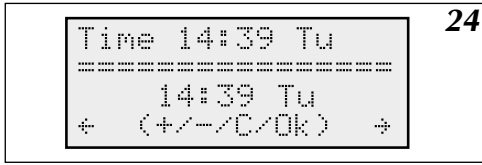





Fig.24 Time

To change hour/minute/day press  or . Press  to save your changes.

Important: If the clock battery runs flat, change the CR 2032 battery located inside of the controller.

Push- buttons specification:

 – return to the main view	 – go to the next page
 – save changes	 – to increase the value
 – go to the previous page	 – to decrease the value

Room temperature sensor.

A room temperature sensor is optional accessory. The room temperature is measured to turn off heating operation in the case of room overheating (when the room is overheated for a reason other than operation of CH system e.g. exposition to the direct sunshine). Controller turns off heating operation when the room temperature exceeds the hysteresis value. The value of hysteresis is expressed in Celsius degrees. For the hysteresis settings details refer to fig.25.

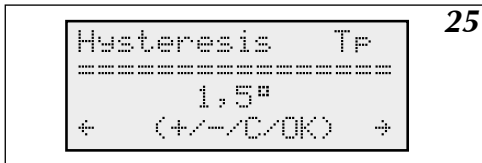

Fig.25 Hysteresis

Hysteresis temperature range is 0,5 - 3,0°C. A controller turns on heating operation shortly after the temperature drops below the temperature that has been set at „24hours temperature” program.

A value of desired room temperature is displayed on the Main View (see page 11). The desired temperature value includes value of hysteresis. Example: If the daily temperature is set at 20°C and the hysteresis value is set at 1°C then the desired room temperature is 1°C degree higher. When controller turns off heating operation due to exceeded temperature limit (daily temp. +hysteresis) the desired temperature is 20°C (daily temperature – hysteresis).

Push- buttons specification:

 – return to the main view	 – go to the next page
 – save changes	 – to increase the value
 – go to the previous page	 – to decrease the value

DHW Pump

To set the DHW pump mode (on/off time) go to page „DHW Pump”. On/off pump mode can be set for every one hour (24hours).

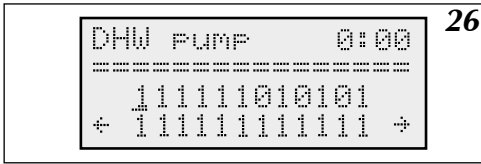

Fig.26 DHW Pump

To change the value (0- 1) press or .

1 – pump „on”
0 – pump „off”

To go to the next hour without changing press .

Push- buttons specification:

- | | |
|---------------------------|---------------------------|
| – return to the main view | – go to the next page |
| – go to the next hour | – to set to 1 (pump „on”) |
| – go to the previous page | –to set to 0 (pump „off”) |

DHW Cylinder

DHW Cylinder temperature reading

Controller enables measuring a water temperature in the cylinder.

To measure the water temperature the cylinder has to be equipped with either a thermostat or the WE-008 KOSPEL temperature sensor.

To set the measurement method (thermostat or WE-008 sensor) go to „Extended Menu” page

For thermostat/sensor wiring details see fig.5 on page 8.

DHW Cylinder programming

To set up a program of DHW Cylinder go to page a or b.

a) „DHW (1)” – 24hr program

b) „DHW (2)” – current temperature reading and setting

You can set the page a) the same way you set the page of DHW pump (refer to DHW pump section)

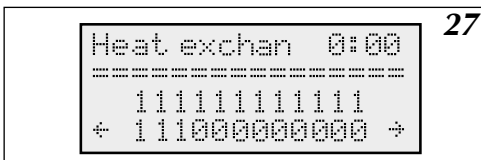

Fig.27 DHW – 24h mode

1 – cylinder „on”
0 – cylinder „off”

In order to ensure an energy efficient operation you can set the DHW Cylinder working time according to hours of the low-tariff rate.

Push- buttons specification:









 – return to the main view	 – go to the next page
 – go to the next hour	 – to set to 1 (DHW „on”)
 – go to the previous page	 –to set to 0 (DHW „off”)



Fig.28 DHW Cylinder with temp. sensor

Fig. 28 and 29 shows the page b) depends on temperature measurement method.

If the sensor is applied the display shows both the current DHW temperature and the desired temperature.

To change desired temperature press  or . To save your changes press . The desired temperature value includes value of hysteresis. The hysteresis value is pre-set in factory to 10 degree. To change hysteresis value go to 'Extended Menu' page.

Failures specification:

'—' sensor disconnection failure

'zw' - sensor short circuit failure

Desired temperature range: 40° do 80°C.

Important! Make sure you save your changes by pressing  button.

Push- buttons specification:

 – return to the main view	 – go to the next page
 – save changes	 – to increase the value
 – go to the previous page	 – to decrease the value

If the thermostat is applied the display shows information as shown in fig 29.

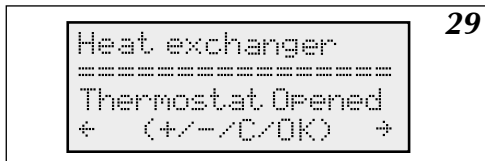

Fig.29 DHW Cylinder with thermostat

'Thermostat opened' - informs that the thermostat contacts are opened.

'Thermostat closed' - informs that the thermostat contacts are closed (DHW heating 'on')

To change the desired temperature value use thermostat knob control.

Heating of the second circuit

Boiler is designed to supply and control two heating circuits (e.g. radiators and under-floor circuit). To control the second circuit (e.g. under-floor) the three-way valve has to be connected to ZIO board. The desired temperature of the second circuit is set on „24h temperature” page. The „N” parameter is set on „Circuit #2” page. (fig.30). To set the heating circuits go to page „Extended Menu”.

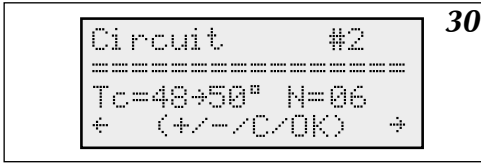

Fig.30 Second circuit

To change „N” parameter value of second circuit press or . To save your changes press .

Push- buttons specification:

– return to the main view	– go to the next page
– save changes	– to increase the value
– go to the previous page	– to decrease the value

Important: To control the second circuit the circuit must be equipped with the following devices: mixing valve, WE-008 Kospel temperature sensor and the second circuit pump (fig.5). Devices connection details:

Mixing valve - ZTM entry

Sensor - Tco2 entry

Pump - Pump 2 entry on ZIO22 board

The sensor measures temperature of CH medium on the second circuit inlet (after the mixing valve). For the mixing valve connection details see fig.4. „ZTM” contacts of ZIO board enables controlling the mixing valve. The mixing valve has to be fixed as shown in fig.5

Central heating parameters

To switch over from the „Main View” to „Heating data” press a .

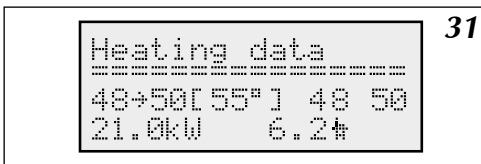

Fig.31 Heating data

„Heating data” display view shows (in sequence): boiler inlet temp, boiler outlet temp, desired temp - in brackets, power (kW) with which the boiler currently heats, flow rate (litres/minute) EKCO.TM model measures the outlet temperatures from both heating boxes (fig.31).

Push- buttons specification:

– return to the main view	– return to the main view
– not applicable	– not applicable
– return to the main view	– not applicable

Failures

To switch over from the „Main View” to „Faults” press or .

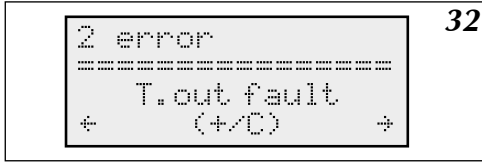

Fig.32 Faults

„Faults” display view shows possible failures: flow failure, outdoor/room temperature sensor failure, inlet /outlet boiler sensor failure. To switch over to the next failure press . The controller enables failure detection and identification (short circuit or sensor disconnection/ missing).

Moreover, the controller shows a flow value in the case of very low rate of flow.

Sensors specification:

Tz – outdoor sensor

Tp – room

Tco-we – inlet boiler sensor

Tco-wy – outlet boiler sensor

Push- buttons specification:

– return to the main view

– go to the next page

– not applicable

– next failure

– go to the previous page

– not applicable

Extended menu

Extended Menu settings can be changed by qualified person only. To edit „Extended Menu” go to „Extended Menu” code page (fig.33) and enter the 3 digit code. To enter the code press or and . Standard factory preset code is „000” or „001”.



Fig.33 „Extended Menu” code

Push- buttons specification:

– return to the main view

– go to the next page

– save the digit

– to change the digit

– go to the previous page

– to change the digit

The code let you go to „Extended Menu” page as shown in fig.34

Fig.34 Extended Menu

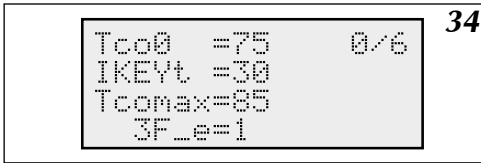

To change parameters press or . To save your changes press .

Push- buttons specification:

– return to the main view	– not applicable
– save changes	– to increase the value
– not applicable	– to decrease the value

Important: The boiler doesn't operate while the parameters are being changed.

Instruction for the user

Heating parameters		fig. 3a or fig.4 - for radiator central heat- ing system	fig.3b – for under-floor heating system
Tco0	CH medium temperature in the case of outdoor temperature sensor failure	70	50
IKEYt	time (sec.) the „Main View” page automatically returns if you don't use any buttons This parameter is not applicable for „Extended Menu” page	30	30
Tcomax	maximum CH medium temperature in the central heating system	85	60
3F_e	1 indicates the symmetry failure , 0 indicates that there is no symmetry failure. Parameter value is 0 for single-phase boilers.		
zew_t	outdoor temperature reading intervals (min.) . 0 indicates the reading for every sec. 1 indicates the reading for every minute	10	10
pok_t	room temperature reading intervals (min.) . 0 indicates the reading for every sec. 1 indicates the reading for every minute	5	5
ZG_MOC	power of the heating box		
NS	number of heating elements	6	6
WChG	radiator coefficient		
	Grz. main circuit (radiator)	Grz.	Pod.
	Nag. main circuit (heater)		
	Pod. main circuit (under-floor heating)		
Tcomin	minimum CH medium temperature in the central heating system.	29	29
PZMR	desired room temperature for antifreeze program	7	7
Nr	number of slave boiler in cascade connection	0	0
code1, code2, code3	three digit code to enter „Extended Menu” .		
Tcwu	outlet boiler temperature (DHW heating)	85	85
Tzas	parameter of the following value:		
	styk if you use cylinder thermostat		
	DS. if you apply Kospel temperature sensor		
Tzas_h	DHW Cylinder hysteresis (Celcius degree)	10	10
Tc2max	maximum heating temperature of the second circuit	60	-

Tc2_0	second circuit temperature in the case of outdoor sensor failure	50	-
Tc2_d	Higher parameter value will affect more delay for the three-way valve opening and closing operation. In the case of the three-way valve outlet oscillation (valve opens or closes too quick) and outlet temperature oscillation then increase the parameter value. Important! If you rise this parameter too far it may slow down the control time too much.	5	5
RP	parameter of the following value:		
Pzmr	if you close the WR contacts on extended module the controller switches for antifreeze program.		
Noc	if you close the WR contacts on extended module the controller switches for night temperature program.		
WChG2	this parameter relates to second heating circuit – see WChG.	Pod.	-
CYRL	value of 0 – display without cyrillic letters, value of 1 – cyrillic letters display		
P	to move the heating curve for the main heating circuit		
P2	to move the heating curve for the second heating circuit		
2Tco	independent view of outlet temperature from the left and right heating box. 0 – view „off“ 1- view „on“		

The last page asks, if you want to return to factory settings. If you enter „TAK“, all settings (except for the heating box power) will return to the standard value. Some of the factory settings e.g. „3F_e“, after completing this function, may be not suitable for this particular version of the boiler or installation system. Please maintain cautious while using this function. When you save your changes, the controller will reset automatically.

Cascade connection

For EKCO.TM the CH parameters shows the working parameters of slave boilers in cascade connection. See fig.35

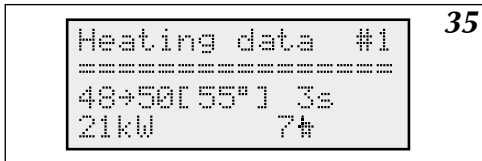

Fig.35 Boiler in cascade connection

The cursor points the ID number of boiler which parameters are being displayed.

Boiler no. 0 – master boiler. To change ID number of boiler press or „CH parameters“ page shows (in sequence): inlet temp., outlet temp., desire temp., time (sec.) that went by from your last successful communication with the boiler.

The last row shows: power (kW) with which the boiler currently heats, current rate of flow (litres/min).

List of figures.

<i>Fig.1</i>	<i>Fixing the boiler to the wall</i>	5
<i>Fig.2</i>	<i>Exemplary scheme of central heating system</i>	6
<i>Fig.3</i>	<i>Exemplary scheme of central heating system– radiators, under-floor heating, DHW cylinder, DHW circuit</i>	6
<i>Fig.4</i>	<i>Connection to the electric mains</i>	7
<i>Fig.5</i>	<i>Connecting external appliances to the ZIO board</i>	8
<i>Fig.5a</i>	<i>Honeywell valve connection diagram</i>	
<i>Fig.6</i>	<i>Boiler in cascade connection</i>	10
<i>Fig.7</i>	<i>Additional electrical connection for boilers in cascade PSK.P4 Controller</i>	10
<i>Fig.8</i>	<i>Control panel</i>	11
<i>Fig.9</i>	<i>Controller reset</i>	11
<i>Fig.10</i>	<i>Main view in configuration „CH ON – DHW ON“</i>	11
<i>Fig.11</i>	<i>Main view in configuration – CH „off“ and DHW „on“</i>	12
<i>Fig.12</i>	<i>Main view in configuration – central heating mode „off“ and DHW mode „off“</i>	12
<i>Fig.13</i>	<i>Language page</i>	13
<i>Fig.14</i>	<i>Configuration view</i>	13
<i>Fig.15</i>	<i>Heating curve</i>	14
<i>Fig.16</i>	<i>Heating curve edit page</i>	14
<i>Fig.17</i>	<i>Heating curve</i>	15
<i>Fig.18</i>	<i>Outdoor temperature limit</i>	15
<i>Fig.19</i>	<i>Working mode</i>	16
<i>Fig.20</i>	<i>24h temperatures settings</i>	16
<i>Fig.21</i>	<i>24h program</i>	17
<i>Fig.22</i>	<i>Week program</i>	18
<i>Fig.23</i>	<i>Pump working mode</i>	18
<i>Fig.24</i>	<i>Time</i>	19
<i>Fig.25</i>	<i>Hysteresis</i>	19
<i>Fig.26</i>	<i>DHW Pump</i>	20
<i>Fig.27</i>	<i>DHW – 24h mode</i>	20
<i>Fig.28</i>	<i>DHW Cylinder with temp. sensor</i>	21
<i>Fig.29</i>	<i>DHW Cylinder with thermostat</i>	21
<i>Fig.30</i>	<i>Second circuit</i>	22
<i>Fig.31</i>	<i>Heating data</i>	22
<i>Fig.32</i>	<i>Faults</i>	23
<i>Fig.33</i>	<i>Extended Menu code</i>	23
<i>Fig.34</i>	<i>Extended Menu</i>	24
<i>Fig.35</i>	<i>Boiler in cascade connection</i>	25



This product must not be treated as a communal waste. Dismantled appliance ought to be given to an appropriate recycling point for electrical and electronic waste. Appropriate disposal of the used product prevents potential negative influence on the environment, which could occur in case of an improper waste disposal.

In order to obtain more detailed information on the recycling of the product, contact your local authority, refuse disposal services or the store, where the product has been purchased.



KOSPEL S.A. 75-136 Koszalin, ul. Olchowa 1, Poland
tel. +48 94 31 70 565
serwis@kospel.pl www.kospel.pl